



# CONDENSING GAS COMBI BOILER

## Owner's Guide

Models : NRCB199DV (GHQ-C3201WX-FF US)  
NRCB180DV (GHQ-C2801WX-FF US)

FOR USE IN RESIDENTIAL OR MANUFACTURED HOME APPLICATIONS.



### WARNING

If the information in this manual is not followed exactly, a fire or explosion may result causing property damage, personal injury, or death.

- Do not store or use gasoline or other flammable vapors and liquids in the vicinity of this or any other appliance.
- WHAT TO DO IF YOU SMELL GAS
  - Do not try to light any appliance.
  - Do not touch any electrical switch; do not use any phone in your building.
  - Immediately call your gas supplier from a neighbor's phone. Follow the gas supplier's instructions.
  - If you cannot reach your gas supplier, call the fire department.
- Installation and service must be performed by a qualified installer, service agency or the gas supplier.

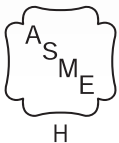

Low NOx Approved  
by SCAQMD  
14 ng/J or 20 ppm  
(Natural Gas Only)



Thank you for purchasing this Noritz Combi Boiler.

Before using, please:

Read this manual completely for operation instructions.

Completely fill out the warranty registration card (included separately) and mail the detachable portion to Noritz America Corporation.

Keep this manual (and the remainder of the warranty registration card) where it can be found whenever necessary.

Installation must conform with local codes, or in the absence of local codes, the National Fuel Gas Code, ANSI Z223.1/NFPA 54 - latest edition and /or the Natural Gas and Propane Installation Code CSA B149.1 -latest edition.

Where required by the authority having jurisdiction, the installation must conform to the Standard for Controls and Safety Devices for Automatically Fired Boilers, ANSI/ASME CSD-1.

Noritz America reserves the right to discontinue, or change at any time, the designs and/or specifications of its products without notice.

### NORITZ America Corporation





# Important Safety Information-1

To prevent damage to property and injury to the user, the icons shown below will be used to warn of varying levels of danger. Every indication is critical to the safe operation of the Combi Boiler and must be understood and observed. Potential dangers from accidents during installation and use are divided into the following four categories. Closely observe these warnings; they are critical to your safety.

## Icons warning of risk level

 This is the safety alert symbol. It is used to alert you to potential personal injury hazards. Obey all safety messages that follow this symbol to avoid possible injury or death.

 <b>DANGER</b>	DANGER indicates an imminently hazardous situation which, if not avoided, will result in death or serious injury.
 <b>WARNING</b>	WARNING indicates a potentially hazardous situation which, if not avoided, could result in death or serious injury.
 <b>CAUTION</b>	CAUTION indicates a potentially hazardous situation which, if not avoided, may result in minor or moderate injury.
<b>CAUTION</b>	CAUTION used without the safety alert symbol indicates a potentially hazardous situation which, if not avoided, may result in property damage.

## Other icons

 Electric Shock.	 High Temperature.	 Be sure to do.	 Ground.	
 Prohibited	 No flame.	 Don't touch.	 Don't disassemble the equipment.	 Don't touch with a wet hand.

## DANGER



Prohibited

**Vapors from flammable liquids will explode and catch fire causing death or severe burns.**

Do not use or store flammable products such as gasoline, solvents or adhesives in the same room or area near the Combi Boiler.

**Keep flammable products:**

- |   |  |
|---|--|
| <ol style="list-style-type: none"> <li>1. Far away from the Combi Boiler.</li> <li>2. In approved containers.</li> <li>3. Tightly closed.</li> <li>4. Out of children's reach.</li> </ol> | <b>Vapors:</b> <ol style="list-style-type: none"> <li>1. Cannot be seen.</li> <li>2. Vapors are heavier than air.</li> <li>3. Go a long way on the floor.</li> <li>4. Can be carried from other rooms to the main burner by air currents.</li> </ol> |
|---|--|



Prohibited

**Hot Water temperature over 125 °F (52 °C) can cause severe burns instantly or death from scalding.**

Children, disabled and elderly are at the highest risk of being scalded. Feel water temperature before bathing or showering. Temperature limiting valves are available, consult with installer.

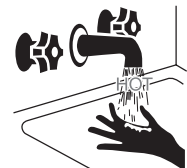

Prohibited

**Do not use the Combi Boiler if the intake/exhaust pipe is displaced, has holes, is clogged, or is corroded.**

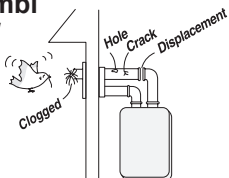

Prohibited

**Do not remove or block the installed safety relief valve for safe operation of the Combi Boiler.**

(Continued)



Prohibited

**Do not use the hot water supplied by the Combi Boiler for drinking purposes.**



Prohibited

**Do not allow anyone to change the domestic hot water temperature while hot water is being used.**

To prevent scalding, do not change the water temperature to a higher setting.



Be sure to do.

**[When supplying combustion air from the indoors]**

**Check whether or not the air supply vent is blocked with dust, trash, a towel, or the like.**

Blocking the opening may result in incomplete combustion.

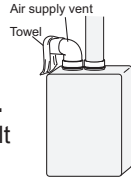

Be sure to do.

**After the Combi Boiler has been out of use for a long time make sure that you fill the condensate trap with water.**

**This is to prevent dangerous exhaust gases from entering the building.**

**Failure to fill the condensate trap could result in severe personal injury or death.**

(☞ Refer to page 27 for further instructions.)

## **WARNING**



No flame.

**A. This Combi Boiler does not have a pilot. It is equipped with an ignition device that automatically lights the burner. Do not try to light the burner by hand.**

**B. BEFORE OPERATING** smell all around the Combi Boiler area for evidence of leaking gas. Be sure to smell next to the floor because some gas is heavier than air and will settle on the floor.

**WHAT TO DO IF YOU SMELL GAS.**

- Do not try to light any appliance.
- Do not touch any electrical switch; do not use any phone in your building.
- Immediately call your gas supplier from a neighbor's phone. Follow the gas supplier's instructions.
- If you cannot reach your gas supplier, call the fire department.

**C. Use only your hand to turn the gas valve knob. Never use tools. If the knob will not turn by hand, don't try to repair it. Call a qualified service technician. Force or attempted repair may result in a fire or explosion.**

**D. Do not use this Combi Boiler if any part has been under water. Immediately call a qualified service technician to inspect the Combi Boiler and to replace any damaged parts.**



Be sure to do.

**When a gas leak is noticed:**

1. Stop use immediately
2. Close the gas valve
3. Open windows and doors



Be sure to do.

**If you detect abnormal combustion or abnormal odors, or during an earthquake, tornado or fire:**

1. Turn off the hot water supply.
2. Turn off the heating system.
3. Turn off the power to the Combi Boiler.
4. Turn off gas, return/supply valve.
5. Call the nearest Noritz agent



Prohibited

**Explosion Hazard ;**

**If the safety relief valve is dripping or leaking, have a qualified service technician replace it. Do not plug or remove the valve.**

Failure to follow these instructions can result in fire or explosion, and personal injury or death



High Temperature.

**Check the temperature of the running hot water before entering the shower.**



**Check the temperature before stepping into the bath tub.**



Be sure to do.

**Should overheating occur or the gas supply fail to shut off, do not turn off or disconnect the power supply to the Combi Boiler. Instead, shut off the external gas supply valve to the Combi Boiler.**

(Continued)

# Important Safety Information-2

(Continued)

## **WARNING**



**Do not place the exhaust vent terminal in an indoor environment by means of adding walls and ceiling (Do not enclose using corrugated sheets, etc.)**

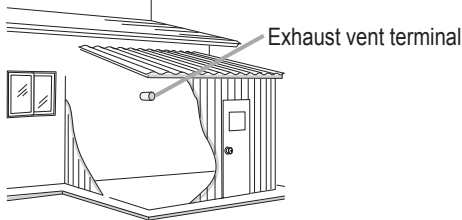

Carbon monoxide poisoning or fire may occur as a result.



Be sure to do.

**Leave the proper clearance between the Combi Boiler and nearby objects (trees, timber, boxes with flammable materials etc.).**

### [Indoor Installation]

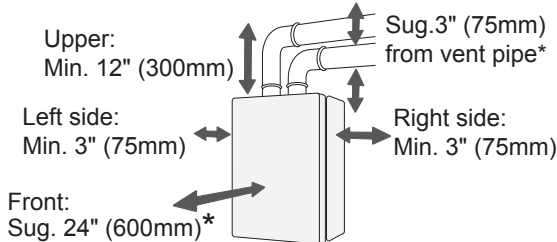

\* Indicates suggested clearances for maintenance.

### [Outdoor Installation]

For information about outdoor installation, contact Noritz America.



**Carbon Monoxide Poisoning Hazard. Do not install this Combi Boiler in a recreational vehicle or on a boat. Do not install this Combi Boiler in a mobile home when using SV conversion kit (“-SV” configuration).**



**Do not place combustibles such as laundry, newspapers, oils etc. near the Combi Boiler or the exhaust vent terminal.**

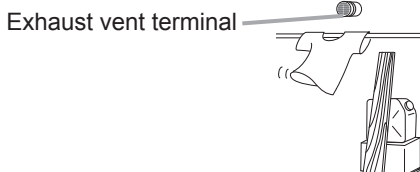

**Do not allow small children to play unsupervised in the bathroom. Do not allow small children to bathe unsupervised.**



**Do not use combustible chemicals such as oil, gasoline, benzene etc. in the near the Combi Boiler or the exhaust vent terminal.**



**Do not store or use gasoline or other flammable vapors and liquids in the vicinity of this or any other appliance.**



**Do not place or use a spray can near the Combi Boiler or the exhaust vent terminal.**



Be sure to do.

**Be sure the gas/power supplied matches the gas on the rating plate.**

e.g. For Natural Gas (NRCB199DV (GHQ-C3201WX-FF US))

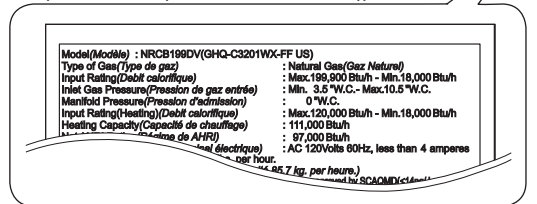
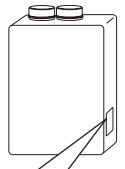

Be sure to do.

**Installation and service must be performed by a qualified installer, service agency or the gas supplier.**



**If this unit will be installed in a location where hair spray or aerosols will be used, locate the unit in a separate area that is supplied with fresh air from outdoors.**



**Do not use hair spray or spray detergent in the vicinity of the Combi Boiler.**



Be sure to do.

**[When supplying combustion air from the indoors]**

**Check the air supply opening for dust or obstructions.**



(Continued)



Don't touch with a wet hand.



Electric Shock.

**Do not touch the power cord with wet hands.**



Don't disassemble the equipment.

**Contact a qualified service technician for any necessary repairs, service or maintenance.**

California Proposition 65 lists chemical substances known to the state to cause cancer, birth defects, death, serious illness or other reproductive harm. This product may contain such substances, be their origin from fuel combustion (gas, oil) or components of the product itself.



Be sure to do.

**Consult the nearest Noritz agent if the Combi Boiler location needs to be changed.**

The gas conversion kit shall be installed by a qualified service agency in accordance with the manufacturer's instructions and all applicable codes and requirements of the authority having jurisdiction. The information in the instructions must be followed to minimize the risk of fire or explosion or to prevent property damage, personal injury, or death. The qualified service agency is responsible for the proper installation of this kit. The installation is not proper and complete until the operation of the converted appliance is checked as specified in the manufacturer's instructions supplied with the kit.



## CAUTION



Ground.

**Be sure to electrically ground the unit.**



Be sure to do.

**Keep power cord free of dust.**



Prohibited

**Do not use a broken or modified power cord. Do not bind, bend or stretch power cords. Do not scratch, modify, or subject them to impact or force.**



Be sure to do.

**To prevent burns or scalding, turn off the power button and wait until the equipment cools before performing maintenance.**



Be sure to do.

**Do not remove the power plug.**

When the power plug is inserted, the unit automatically operates the circulation pump for several seconds when the unit has not been used for approximately 30 days to prevent the circulation pump from malfunctioning due to build-up of lime deposits.



Prohibited

**Do not turn off the Combi Boiler while someone is bathing.**



Prohibited

**Do not cover the Combi Boiler and the exhaust vent terminal, store trash or debris near it, or in any way block the flow of fresh air to the unit.**



Prohibited

**Do not install in locations where excessive dust or debris will be in the air.**



Don't touch.

**Do not touch the exhaust vent pipe and exhaust vent terminal or immediately after operation of the Combi Boiler.**



Be sure to do.

**Replace the Combi Boiler water as required by the anti-freeze manufacturer.**

- Not replacing the Combi Boiler water will cause rusting and freezing, resulting in damage to the device and radiator. Repairs resulting from deterioration of the anti-freeze are not covered by the warranty.
- For replacement of the Combi Boiler water, contact the installer or a qualified service technician. Costs for the replacement of the anti-freeze are not covered by the warranty.



Prohibited

**Do not use condensate, discharged from the drain pipe, for drinking or for consumption by animals.**

# Important Safety Information-3

## CAUTION

**Do not drink water that has been inside the unit for an extended period of time. Do not drink the first use of hot water from the unit in the morning.**

---

**Clean the filter on the water inlet as frequently as required by the quality of your local water.**

---

**Keep the area around the unit clean.**

If boxes, weeds, cobwebs, cockroaches etc. are in the vicinity of the unit, damage or fire can result.

---

**Do not install the equipment where the exhaust will blow on walls or windows.**

---

**If the water supply is in excess of 12 grains per gallon (200 mg/L) of hardness, acidic or otherwise impure, treat the water with approved methods in order to ensure full warranty coverage. (→p.31)**

---

**Problems resulting from scale formation are not covered by the warranty.**

---

**Check ignition during use and extinction after use.**

---

**Do not run water through the unit when the unit is not on.**

When discharging hot water, make sure the unit is ON. If water is run through the unit with the unit OFF, water may condense inside the unit and cause incomplete combustion or damage to the internal electrical components.

For single-handle fixtures, you'd turn the handle to the left.

---

**Do not use parts other than those specified for this equipment.**

**This unit is only approved for installation up to 4500ft (1350m) above sea level.**

For installations at higher elevations, contact Noritz America for Instructions.

---

**Do not disassemble the Operation Panel.**

**Do not use benzene, oil or fat detergents to clean the Operation Panel.**

This may cause deformation.

**Do not get the Operation Panel wet.**

It is not water resistant, water can cause damage.

**Do not splash water on the Operation Panel. Do not expose the Operation Panel to steam.**

Do not locate the Operation Panel near stoves or ovens, this may cause damage or failure.

---

**Preventing damage from freezing (→p.24)**

Damage can occur from frozen water within the device and pipes even in warm environments. Be sure to read below for appropriate measures. Repairs for damage caused by freezing are not covered by the warranty.

---

**Take necessary measures to prevent freezing of water and leakage of gas when leaving the unit unused for long periods of time. (→p.26)**

---

**If it is snowing, check the flue terminal for blockage.**

---

**Do not use the unit in high humidity place.**

If the unit is used in a place with high humidity, the inside of the unit and/or the unit may condensate and cause incomplete combustion, damage to the electrical components or electric leakage.

# Contents

Important Safety Information .....	2
Contents.....	7
<b>General Parts</b>	
<b>Main Unit.....</b>	<b>8</b>
<b>Operation Panel.....</b>	<b>10</b>
<b>Initial Operation.....</b>	<b>12</b>
<b>How to Use</b>	
<b>Clock Setting .....</b>	<b>13</b>
<b>Setting Domestic Hot Water Temperature (DHW) .....</b>	<b>14</b>
<b>Setting Heating Temperature .....</b>	<b>16</b>
<b>Setting DHW Preheat Timer .....</b>	<b>17</b>
<b>Activate DHW Preheat .....</b>	<b>19</b>
<b>Customizable Settings &lt;User Mode&gt; .....</b>	<b>20</b>
<b>Guide for Functions .....</b>	<b>22</b>
<b>View Technical Data.....</b>	<b>23</b>
<b>Preventing Damage from Freezing.....</b>	<b>24</b>
<b>Regular Maintenance .....</b>	<b>28</b>
<b>Troubleshooting .....</b>	<b>32</b>
<b>Follow-up Service .....</b>	<b>37</b>
<b>Specifications.....</b>	<b>39</b>

# General Parts -1

## Main Unit

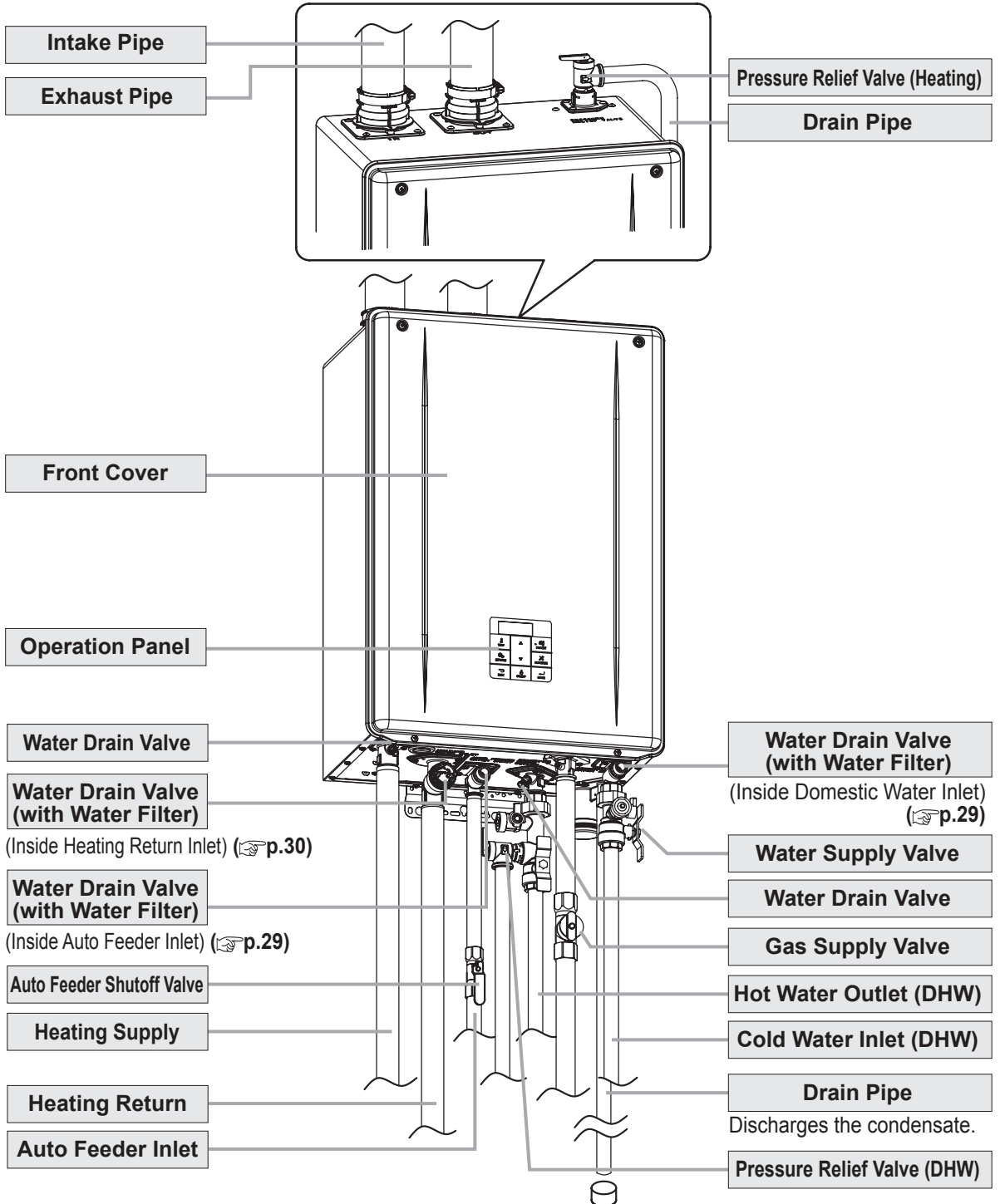

\* The above illustration shows an example of installation.  
The exact installation configuration may be slightly different.



### **The Condensing Gas Combi Boiler discharges condensate.**

When heat from the exhaust gas is collected within the secondary heat exchanger, condensation occurs from moisture in the exhaust gas and the resulting water is discharged from the drain pipe (approx. 2 gallons/hour (7.5 liters/hour) maximum). It is not a water leak. Do not plug or block the drain line as it must always be allowed to freely flow.

Note : The condensate discharged is acidic with a pH level of approximately 2-3.  
A condensate neutralizer may be required by local code prior to disposal.

### **The Condensing Gas Combi Boiler tends to show white steam.**

After the exhaust gas passes through the secondary heat exchanger, the low temperature and high moisture content tends to produce steam at the vent discharge terminal. This is a normal occurrence.

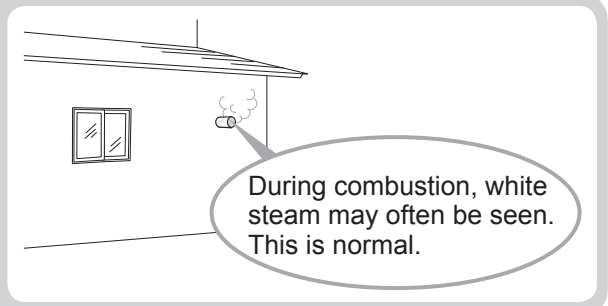

# General Parts -2

## Operation Panel (RC-B201M)

The Operation Panel will emit a tone when a button is pressed.

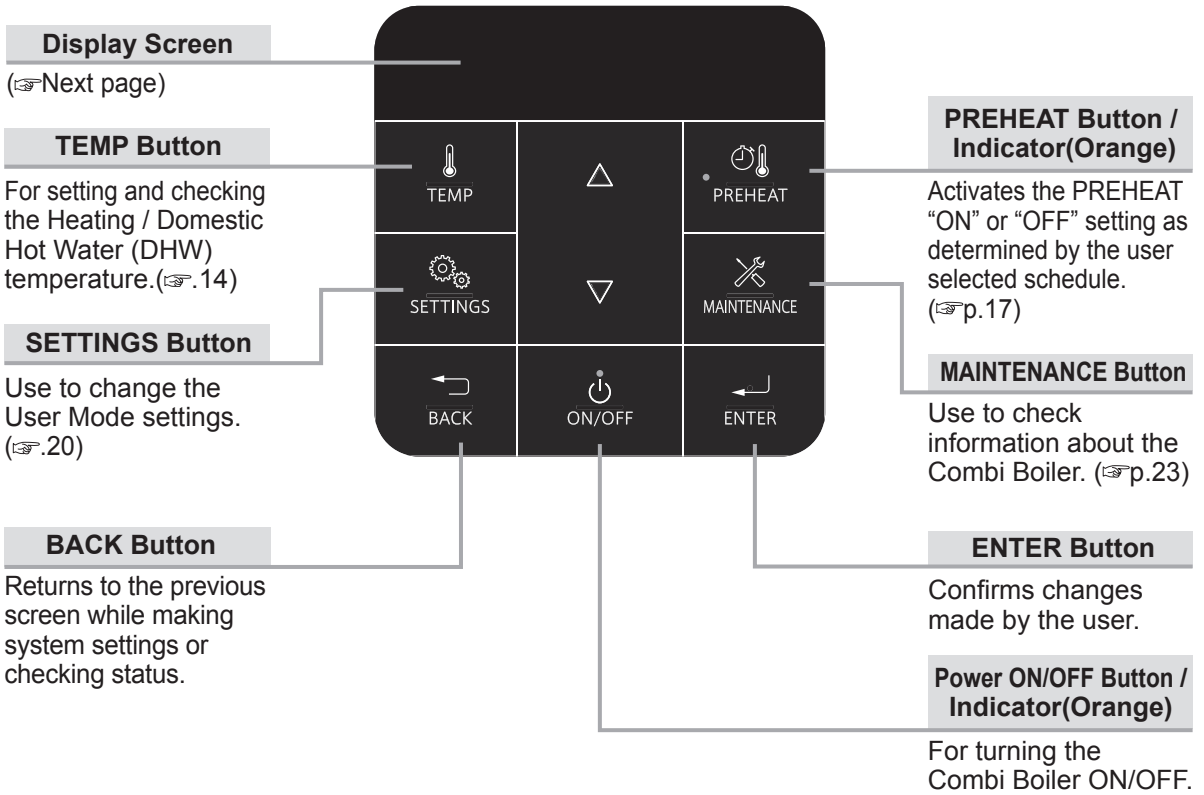

## ● Display Screen ●

\* The Display Screen shown below is for illustration purposes only.  
The actual display will vary depending on how the Combi Boiler is being used.

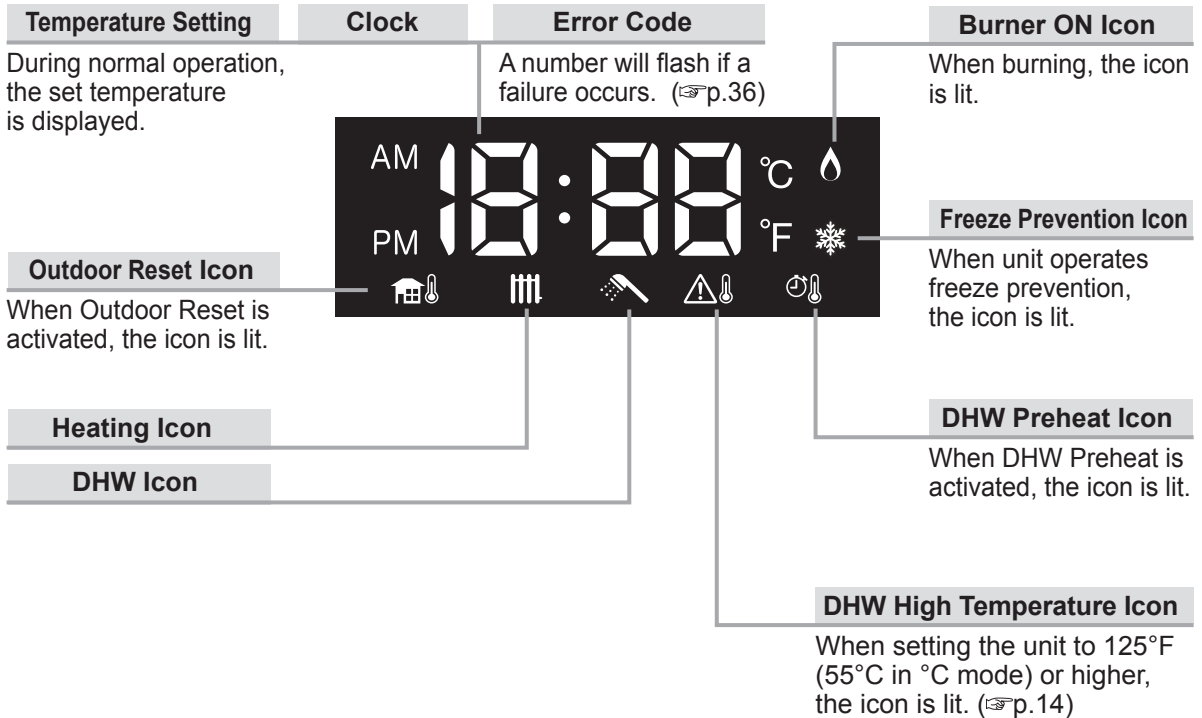

\* Before use, remove the protective sheet from the Operation Panel surface.

Note: As shipped from the factory, the Operation Panel is set to display in °F and gallons.  
To adjust the display to °C and liters, refer to the Installation Manual.

# Initial Operation

Before the first use of your Combi Boiler do the following:

Follow steps **1 through 5**.

**1** Open the water supply valve and the auto feeder shutoff valve.

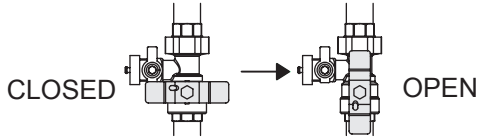

**2** Open a hot water fixture to confirm that water is available, and then close the fixture again.

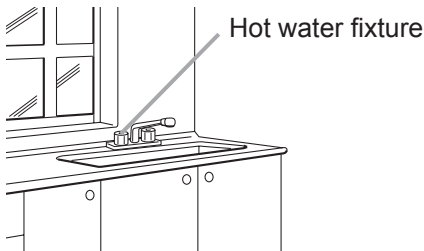

**3** Open the gas supply valve.

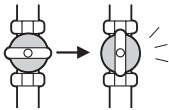

**4** Turn on the power.





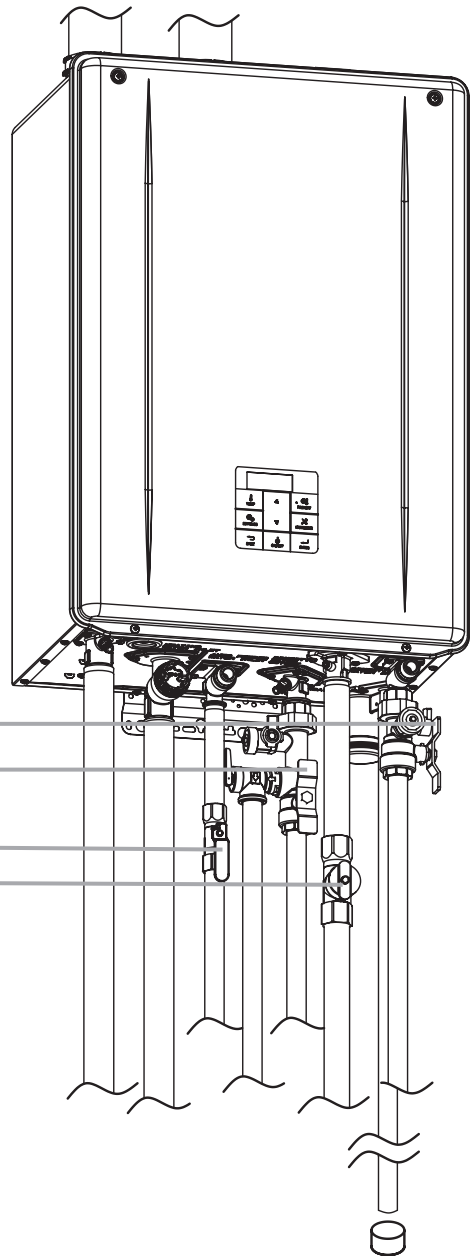
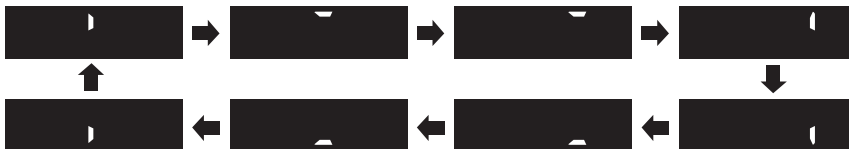



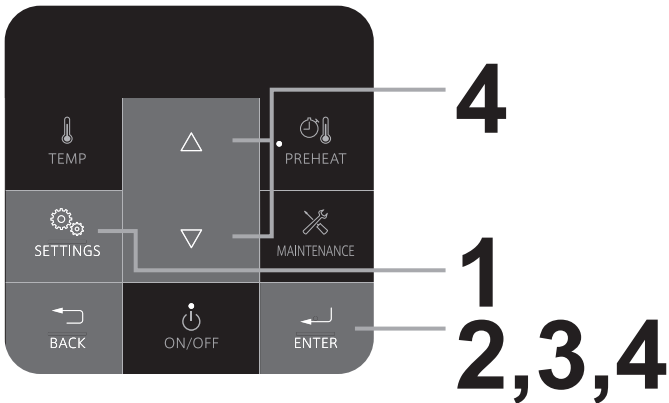



**Do not touch with wet hands.**

**5** The unit starts auto feeding for heating. The display will change to the following rotational pattern. This is normal operation. When auto feeding is complete, the rotational pattern turns off automatically.



# Clock Setting







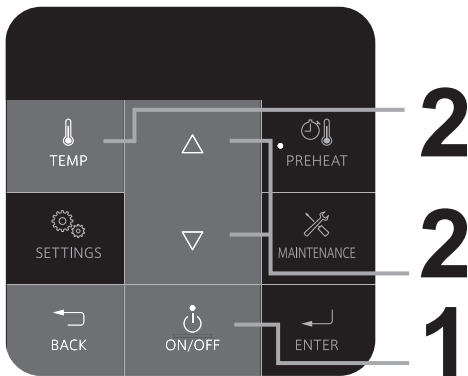

Operation	Screen Display	Description
<b>1</b> Press the  button.		* This setting can be done regardless of whether the  button is ON/OFF.
<b>2</b> Press the  button.	 ▼ After 1 sec.  (CLS:CLock Setting)	
<b>3</b> Press the  button.		
<b>4</b> <ol style="list-style-type: none"> <li>1) Press the  buttons until the correct time is displayed.</li> <li>2) Press the  button to save the current setting.</li> </ol>	 (e.g.: 10:15AM)	* Each press of the button changes the time in 1-minute increments. Press and hold the button will change the time in 10-minute increments.  * If the display is left untouched for approximately 30 seconds without pressing the  button, the setting will be completed. When the  button is pressed, the screen display will show "CLS".

\* In the event of a power outage or after disconnecting power to the Combi Boiler, the Combi Boiler stores the time at regular intervals. If this happens and power is restored, the clock time will be blinking. If you find the clock blinking, readjust the clock time.

# Setting Domestic Hot Water Temperature (DHW)



Operation	Screen Display	Description
<b>1</b> Press the  button ON.	 (e.g.: 10:15AM)	* The  indicator is lit.
<b>2</b> Press the  button twice. The current "DHW Temperature Setting" and "DHW Icon" will be blinking. Set the temperature using the  buttons.	 (e.g.: 110°F)	* To return to the home screen, press the  button or let panel sit for approximately 20 seconds.

## DANGER



To prevent scalding:  
High Temperature

**Hot Water temperatures over 125°F (52°C) can cause severe burns instantly or death from scalding.**

- Children, disabled and elderly are at the highest risk of being scalded. Feel water temperature before bathing or showering. Temperature limiting valves are available, check with installer.
- When setting the unit to 125°F (55°C in °C mode) or higher, the DHW High Temperature Icon will flash for 10 seconds and emit a tone as a high temperature warning.
- Take caution when using the unit again after setting to 125°F (52°C) or higher. Always check the set temperature before use.
- Do not allow anyone to change the water temperature while hot water is running.

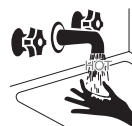

Operation Panel Display



Flashes for 10 sec



**■ When using °F mode:**

(°F: The temperature settings below are examples. The temperature setting necessary depends on the usage, the length of piping and the time of year.)

The maximum output temperature can be set using the Operation Panel. (☞p.20)

<b>90</b>	<b>95</b>	<b>100</b>	<b>105</b>	<b>110</b>	<b>115</b>	<b>120</b>	<b>125</b>	<b>130</b>	<b>135</b>	<b>140</b>
Washing dishes, etc.			Shower, hot water supply, etc.				High temperature			

\*Initial factory setting is 110°F

**■ When using °C mode:**

(°C (°F): The temperature settings below are examples. The temperature setting necessary depends on the usage, the length of piping and the time of year.)

The maximum output temperature can be set using the Operation Panel. (☞p.20)

<b>32</b>	<b>35</b>	<b>37</b>	<b>38</b>	<b>39</b>	<b>40</b>	<b>41</b>	<b>42</b>	<b>43</b>	<b>44</b>	<b>45</b>	<b>46</b>	<b>47</b>	<b>48</b>	<b>50</b>	<b>55</b>	<b>60</b>
(90)	(95)	(99)	(100)	(102)	(104)	(106)	(108)	(109)	(111)	(113)	(115)	(117)	(118)	(122)	(131)	(140)
Washing dishes, etc.			Shower, hot water supply, etc.											High temperature		

\*Initial factory setting is 40°C (104°F)

If fixtures incorporate mixing valves, set the temperature higher than usual.

- \* For most residential applications, the recommended temperature setting is 120°F (50°C in °C mode) or less.
- \* Consult local codes for minimum operating temperatures.

Note : Noritz recommends that water temperature is set as low as possible to prevent scale build-up in the heat exchanger.

# Setting Heating Temperature

- Blinking (🏠) on the Operation Panel is not an Error Code.
- The unit has the "Outdoor Reset (Energy Saving)" feature, but this feature is disabled (Factory Default).
- To enable, contact your installer or Noritz America Technical Support at 866-766-7489.
- (🏠) is lit on the Operation Panel, the Outdoor Reset (Energy Saving) is enabled.
- Heating Temperature is changing automatically based on the Outdoor Temperature.
- \* Refer to page 22 for details.

The following Heating Temperature Setting can be changed when the "Outdoor Reset" is disabled.

General temperature range (Factory Default*)		
°F	100	180
		Initial factory setting
°C	38	82





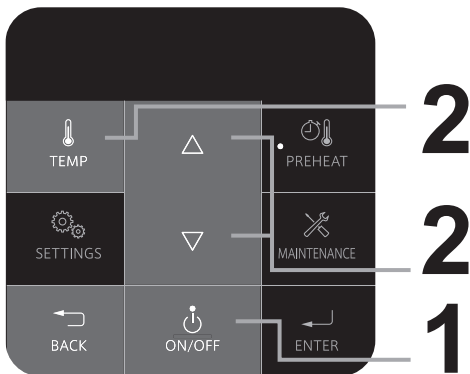

The temperature setting below is example.

The temperature setting necessary depends on the usage, the length of piping and the time of year.

\* Heating Temperature range depends on Installer Mode Setting.

Refer to the Installation Manual for details.



Operation	Screen Display	Description
<b>1</b> Press the  button ON.	 (e.g.: 10:15AM)	* The  indicator is lit.
<b>2</b> Press the  button once. The current "Heating Temperature Setting" and "Heating Icon" will be blinking. Set the temperature using the  buttons.	 (e.g.: 180°F)	* To return to the home screen, press the  button or let panel sit for approximately 20 seconds.



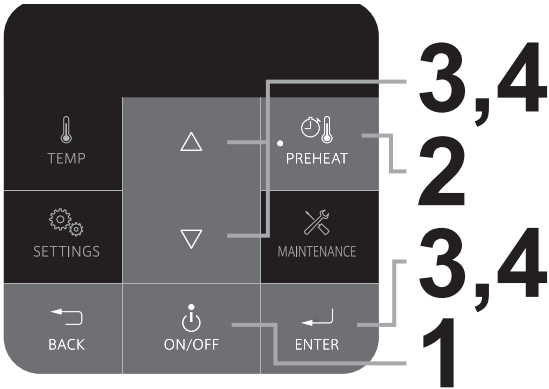

# Setting DHW Preheat Timer







This example shown is setting the "ON time" and "OFF time" to 6:00PM and 7:00PM.



**1** Press the  button ON.   
(e.g.: 10:15AM)



**2** Press and hold the  button for approximately 2 seconds.   
(e.g.: 12:00PM)



- \* In order to use the DHW Preheat function, the clock must be set first. The DHW Preheat Timer is disabled until the clock is set.
- \* When entering DHW Preheat Timer setting mode, the clock display will be blinking.
- \* When the preheat function is activated, you cannot set DHW Preheat Timer.

**3** 1) Press the  buttons until 'the desired time' is displayed.   
(e.g.: 6:00PM)

2) Press the  button to save the current setting. (DHW Preheat Icon is lit)   
(e.g.: 6:00PM)

- \* Time changes in 30-minute increments when each button is pressed.
- \* If you want to set the ON time OFF, select the desired time by using the  buttons. And then press button .
- \* To return to the home screen, press the  button or let panel sit for approximately 20 seconds.

**4** 1) Press the  buttons until 'the desired time' is displayed.   
(e.g.: 6:30PM)

2) Press the  button to save the current setting. (DHW Preheat Icon is lit)   
(e.g.: 6:30PM)

- \* DHW Preheat Icon will appear to confirm when the preheat function is scheduled for that 30 minute block. If it is not present, the preheat function is off.

e.g. DHW Preheat is scheduled to run 6:00PM - 7:00PM.

AM											
12	1	2	3	4	5	6	7	8	9	10	11
PM											
12	1	2	3	4	5	6	7	8	9	10	11

e.g. DHW Preheat is scheduled to run 7:00AM - 8:00AM, 11:30AM - 1:00PM and 6:00PM - 9:00PM.

AM											
12	1	2	3	4	5	6	7	8	9	10	11

PM											
12	1	2	3	4	5	6	7	8	9	10	11

**Screen Display**

- 1) AM 6:30
- 2) AM 7:00
- 3) AM 7:30
- 4) AM 8:00

**Screen Display**





- 1) AM 11:00
- 2) AM 11:30
- 3) PM 12:00
- 4) PM 12:30
- 5) PM 1:00

**Screen Display**

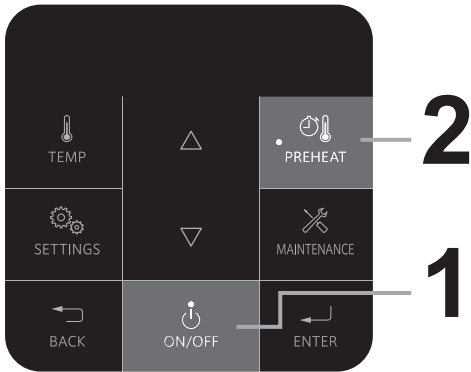
- 1) PM 5:30
- 2) PM 6:00
- 3) PM 6:30
- 4) PM 7:00
- 5) PM 7:30
- 6) PM 8:00
- 7) PM 8:30
- 8) PM 9:00

# Activate DHW Preheat



Operation	Description
<b>1</b> Press the  button ON.	* When Operation Panel is OFF, you can not activate DHW Preheat.
<b>2</b> Press the  button.	* When Preheat is activated,  indicator is lit. * To deactivate DHW Preheat, Press the  button.

## ● To Confirm DHW Preheat Operation

When Preheat is operating,  
DHW Preheat Icon is lit.



# Customizable Settings <User Mode>



## Muting the Operation Panel.

The Operation Panel can be muted so that no tone is emitted when a button is pressed.

**1** Press the button,  
Select using the buttons.

Press the button.

The "User Mode" screen appears.

**2** Select using buttons,  
After 1 sec. (SoS:Sound Setting)

press the button.

**3** Change the setting using the buttons.

(e.g.: ON)

ON:the Operation Panel is not muted.

OFF:the Operation Panel is muted.

(Default setting=ON)

Setting completed

## Adjusting the DHW Maximum Output Temperature.

The DHW maximum output temperature can be limited to prevent discharging hot water at too high of a temperature.

**1** Press the button OFF.  
The Operation Panel must be off.

**2** Press the button,  
Select using the buttons.

Press the button.

The "User Mode" screen appears.

**3** Select using buttons,  
After 1 sec. (dL:DHW Max Temperature Limitation)

press the button.

**4** Change the setting using the buttons.

(e.g.: 120°F)

[For Fahrenheit (°F)]  
90 - 140°F (In 5°F intervals)

[For Celsius (°C)]  
32, 35, 37 - 48°C (In 1°C intervals),  
50,55,60°C

(Initial setting=120°F / 50°C)





Setting completed





To return to the home screen, press the button three times or let it sit for approximately 30 seconds.



To change other settings, Select option and press the button.



## Temperature Lock.

Temperature Settings can be locked so that it does not change temperature setting if a button is pressed by mistake. Both DHW and Heating temperature setting are locked.

- 1 Press the  button, Select  using the  buttons. Press the  button. The "User Mode" screen appears.

- 2 Select  using  After 1 sec.  (LoC:Temperature Lock) the  buttons, and then press the  button.

- 3 Press and hold the  button for approximately 2 seconds to turn "ON".  (e.g.: ON)

-  ON:the temperature setting is locked.
-  OFF:the temperature setting is not locked.





(Default setting=OFF)





\* If you want to set "Temperature Lock" from "ON" to OFF", press and hold the  button for approximately 2 seconds to turn "OFF".



Setting completed

## Draining the Combi Boiler.

(☞ Refer to page 26 for details.)

- 1 Press the  button OFF. The Operation Panel must be off.
- 2 Press the  button, Select  using the  buttons. Press the  button. The "User Mode" screen appears.

- 3 Select  using  After 1 sec.  (drA:Drain The Water) the  buttons, and then press the  button.

- 4 Press and hold the  button for approximately 2 seconds to turn "ON".  (e.g.: ON)



- 5 Drain the Combi Boiler following the procedures described on page 26.

During draining, the display will change to the following rotational pattern.

When the drain the water is complete, "the rotational pattern" turns off automatically.



To stop draining water from the Combi Boiler

Press the  button during draining, the drain function will be stopped and the screen display shows .

To return to the home screen, press the  button three times or let it sit for approximately 30 seconds.

To change other settings, Select option and press the  button.

# Guide for Functions

## Simultaneous use for DHW and Heating

This Combi Boiler can operate DHW and Heating at the same time.

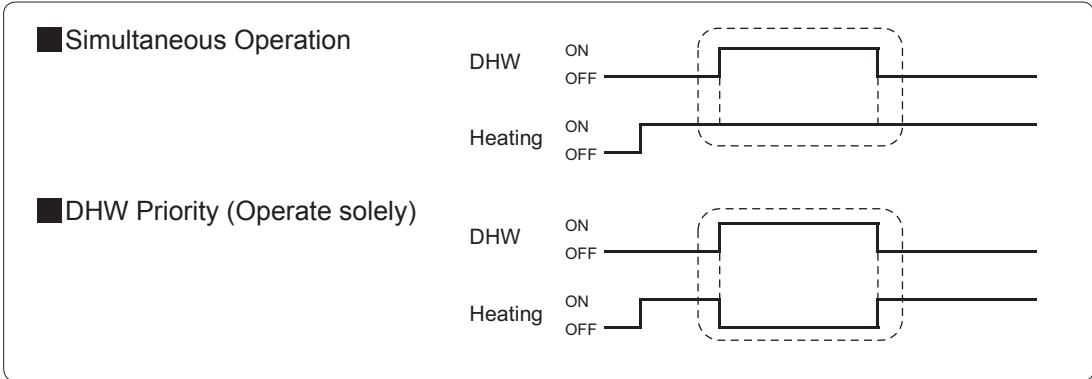

However it can not operate in every conditions. The range of simultaneous use for DHW and Heating will be decided by both the "Heating Set Temperature" and "DHW Set Temperature".

<Recommended Temperature Setting for using DHW and Heating at the same time>

DHW temperature setting: 120°F(50°C in °C mode) or less.

Heating temperature setting: 180°F(82°C in °C mode)

\*Higher Heating temperature is better.

<Unsuitable Conditions>

- Heating supply temperature setting is under 140°F (60°C in °C mode).
- When DHW temperature setting is 140°F (60°C in °C mode).

<DHW Priority>

When DHW/Space Heating Priority (Installer Mode [I:16\_dHP]) is set to [2:dH].

\* If the is lit (not flashing), then the Combi Boiler operates simultaneously DHW and Heating automatically by increasing the heating supply temperature.

\* Contact Noritz America for more information about simultaneous use for DHW and Heating.





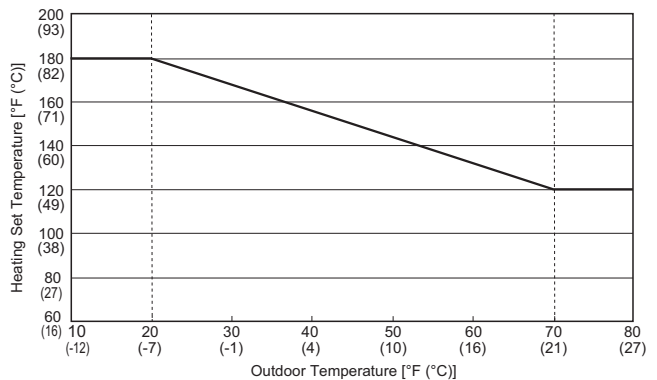



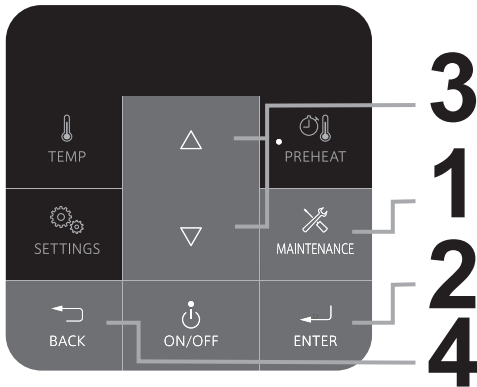

## Outdoor Reset

is lit on the Operation Panel, the Outdoor Reset (Energy Saving) is enabled. The Outdoor Reset Control feature may be used to enhance energy efficiency while maintaining optimal heating performance. With the Outdoor Reset Control, the heating temperature setting automatically changes according to the outdoor temperature and the current heating system application. The graph shows an example relationship between Outdoor Temperature and Heating Set Temperature.



# View Technical Data



Operation	Screen Display	Description
<b>1</b> Press the  button.	 (td:technical data)	* This setting can be done regardless of whether the  button is ON/OFF.
<b>2</b> Press the  button.	 (Data No. 03) ▼ After 2 sec.  (e.g.: 100)	
<b>3</b> Press the  buttons to navigate through the 'Technical Data'. (☞ Refer to the below table of technical data.)	 (Data No. 35) ▼ After 2 sec.  (e.g.: 180°F)	* Press and hold the button to change it in increments of 10.
<b>4</b> To return to the home screen, press the  button twice or let it sit for approximately 10 minutes.		

## Technical Data List

Data No.	Item	Data (Display Reading X Multiplier)	
		Multiplier	Unit
30	DHW Cold Temperature	× 1	°F
		× 0.1	°C
35	Heating Supply Temperature	× 1	°F
		× 0.1	°C
67	Heating Water Pressure	× 0.1	psi

# Preventing Damage from Freezing-1

## CAUTION

- \* Damage can occur from frozen water within the device and pipes even in warm environments. Be sure to read below for appropriate measures.
- \* Repairs for damage caused by freezing are not covered by the warranty.

Freezing is prevented within the device automatically by operating the pump and turning on the burner.

## Perform the following to prevent freezing

### ■ Do not remove the power plug

Freezing cannot be prevented when the power plug is disconnected.

### ■ Do not close the gas valve and water valve

The unit will automatically operate (combust) to warm the water within the circuit to prevent freezing.  
Note: Freezing of water within the circuit may not be prevented depending on the heating system. For details, contact your installer.

Freezing will be prevented regardless of whether the operation switch is ON or OFF.

- \* In normal operation, freezing is prevented within the device automatically unless the outside temperature without wind is below  $-30^{\circ}\text{F}$  ( $-35^{\circ}\text{C}$ ).
  - When supplying combustion air from the indoors, the room temperature must be greater than  $32^{\circ}\text{F}$  ( $0^{\circ}\text{C}$ ) to prevent freezing and the room inside must not have negative pressure.
- \* The freeze prevention of the Combi Boiler will not prevent the plumbing external to the unit from freezing. Protect this plumbing with insulation, heat tape or electric heaters, solenoids, or pipe covers. If there remains a freezing risk, contact the nearest Noritz agent.

### Take the measures below for extremely cold temperatures\*.

Outside temperature including wind chill factor less than  $-30^{\circ}\text{F}$  ( $-35^{\circ}\text{C}$ ).

- When supplying combustion air from the indoors, the room temperature must be greater than  $32^{\circ}\text{F}$  ( $0^{\circ}\text{C}$ ) to prevent freezing and the room inside must not have negative pressure.

This method can protect not only the heater, but also the water supply, water piping and mixing valves.

1. Turn off the power.
2. Close the gas supply valve.
3. Open a hot water fixture/faucet, and keep a small stream of hot water running. (0.1 gallon (400cc)/minute or about 0.2" (4mm) thick).
  - \* If there is a mixing valve, set it to the highest level.
  - \* When linking multiple units, discharge water equivalent to 0.1 gallon (400cc)/minute per unit.
4. The flow may become unstable from time to time. Check the flow 30 minutes later.
  - \* In general, it is not advisable to run water through the unit when it is OFF ( p. 6), but in this case freeze prevention is more important.

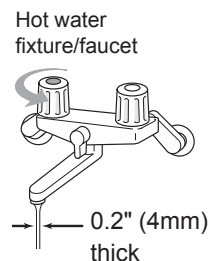

- \* Remember to set mixing valves and fixtures to their original levels before using the unit again to prevent scalding.
- \* If there is still a risk that the unit will freeze, drain the unit as shown on the next page.



## **If water will not flow because it is frozen**

1. Close the gas and water valves.
2. Turn off the power button.
3. Open the water supply valve from time to time to check whether water is running.
4. When the water is flowing again, check for water leaks from the equipment and piping before using.

If the Combi Boiler or the piping is frozen, do not use the Combi Boiler or it may get damaged.

# Preventing Damage from Freezing-2

If the Combi Boiler will not be used for a long period of time, drain the water.

Drain the water as follows:



To avoid burns, wait until the equipment cools down before draining the water. The appliance will remain hot after it is turned off.

To prevent damage from freezing, the Combi Boiler must be plugged into power at all times. If power is unplugged, drain the water completely from the Combi Boiler. Then use an air compressor to remove all water from inside the unit's water piping. It is recommended that Isolation Valves are installed on the Combi Boiler, otherwise the water connections will need to be removed to drain the unit completely. Freeze damage due to not draining properly will not be covered under warranty.

Drain water into a bucket to prevent water damage.

## Drainage Using the Operation Panel

- (1) Press the button OFF.  
The Operation Panel must be off.

(2) Press the button, Select using the buttons. Press the button.  
The "User Mode" screen appears.

(3) Select using the buttons, and then press the button.

(4) Press and hold the button approximately 2 seconds to turn "ON".



(☞ Refer to page 21 for details.)

- Close the water supply valve and the auto feeder shutoff valve. (☞ p. 8)

- Fully open all hot water fixtures/faucets.

- Open all drain plugs and drain the water out of the unit.

- When the screen display turns off, replace all drain plugs and close the hot water fixtures/faucets.

- Close the gas valve and disconnect the electrical power supplied to the unit.

**Do not touch with wet hands.**

## Manual Draining

- Close the gas valve.

- (1) Turn the power button on.

(2) Turn and leave open the hot water fixtures/faucets for more than 2 minutes and close.

  - \* If multiple units are being used, drain two minutes for each unit.
  - \* An 11 Error Code may appear on the Operation Panel. This is not a malfunction of the unit. Do not turn the power button off.

- Close the water supply valve and disconnect the electrical power supplied to the unit.

**Do not touch with wet hands.**

- Fully open all hot water fixtures/faucets.

- Open all drain plugs and drain the water out of the unit.

- When the water is completely drained, replace all drain plugs and close the hot water fixtures/faucets.

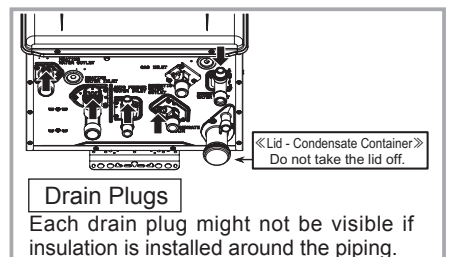

## Turning the Unit Back On

1. Check that all drain plugs are inserted.
2. Check that all hot water fixtures/faucets are closed.
3. Follow the procedure on p.12 "Initial operation", steps 1 through 5.
4. Make sure that the area around the appliance is well ventilated; open a window or a door if necessary. Then, operate the unit and verify that condensate is coming out of the drain pipe.  
(During normal use of the Combi Boiler, condensate will begin to discharge from the drain pipe within 15 minutes of use. However, depending on the season and/or installation site conditions, it may take longer.)

\* If water does not appear at the end of the drain line, a qualified service technician must clean the condensate line.

### **DANGER**



Be sure to do.

After the Combi Boiler has been out of use for a long time make sure that you fill the condensate trap with water.

This is to prevent dangerous exhaust gases from entering the building.

Failure to fill the condensate trap could result in severe personal injury or death.

(By performing step 4 as described above, the condensate trap will automatically fill itself with water.)

# Regular Maintenance-1

## Periodic Inspection

### CAUTION



To prevent burns or scalding, turn off the power button and wait until the equipment cools before performing maintenance.

Be sure to do.

[When supplying combustion air from the indoors]

**Check** For smear or blockage with dust, oil, etc. at the air supply vent. If blocked, remove the build-up with a vacuum cleaner or damp towel.

\* Do not permanently remove the Inlet Screen.

**Check** For proper operation of pressure relief valve.

**Check** For laundry, newspaper, timber, oil, spray cans and other combustible materials near the heater or the exhaust vent terminal.

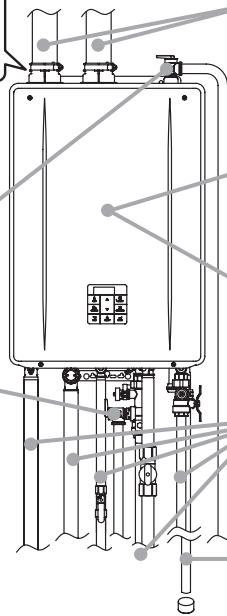
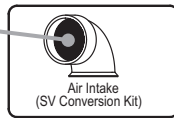

**Check** For dust and soot in the exhaust vent or exhaust vent terminal.

**Check** For abnormal sounds during operation.

**Check** For abnormalities in external appearance, discoloration or flaws.

**Check** For water leaks from the equipment and piping.

**Check** For blockage at the drain pipe discharge.

### Expansion Tank

Inspect the expansion tank once a year for proper air pressure within the tank. Follow the instructions of the expansion tank manufacturer. For inspection, contact your installer or a qualified service technician.

### Safety Relief Valve

Inspect the safety relief valve once a year to see if the valve works correctly. For inspection, contact your installer or a qualified service technician.

## Periodic Maintenance

### Unit

Wipe the outside surface with a wet cloth, then dry the surface. Use a neutral detergent to clean any stains. If an external condensate neutralizer is installed, periodic replacement of the neutralizing agent will be required. Refer to the instructions supplied with the neutralizer for suggested replacement intervals.

### Operation Panel

Wipe the surface with a wet cloth.

- Do not use benzene, oil or fatty detergents to clean the Operation Panel; deformation may occur.
- The Operation Panel is not water resistant. Keep it dry.

## Periodic Maintenance

### Water Drain Valve (with Water Filter)

If the water drain valve (with water filter) is covered with debris, the hot water may not run smoothly, or the unit may put out cold water. Check and clean the filter as explained below.

- \* **To avoid burns, wait until the unit cools down before draining the water.**  
**The unit will remain hot after it is turned off.**

### Domestic Water Inlet / Auto Feeder Inlet

1. Close the water supply valve. Press the power button to turn off the Operation Panel and disconnect the power cord to the Combi Boiler.
2. Open all hot water fixtures/faucets.
3. With a bucket ready, remove the DHW inlet, the DHW outlet and the Auto feeder inlet drain plugs. (about 0.13 gallon (0.5 L) will drain out)
4. Remove the water drain valves (with water filter) out of the inlets. (See illustration to right).
5. Clean the water drain valves (with water filter) with a brush under running water.
6. Replace the water drain valves (with water filter) and close the drain plugs. (Take care not to lose the packing.)
7. Close all hot water fixtures/faucets.
8. Open the water supply valve and check that water does not leak from the drain plugs or water drain valves (with water filter).
9. Plug back the power cord and press the power button to power the unit on and readjust the clock time. (→p. 13)

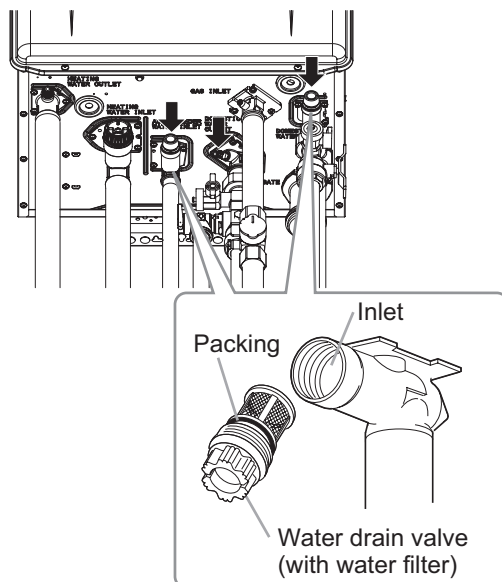

# Regular Maintenance-2

## Periodic Maintenance

### Water Drain Valve (with Water Filter)

#### ■ Heating Water Inlet

1. The Operation Panel is OFF and disconnect the power cord to the Combi Boiler.
2. With a bucket ready, remove the inlet and outlet drain plugs (about 0.76 gallon (2.9 L) will drain out)
3. Remove the water drain valve (with water filter) out of the inlet. (See illustration below).
4. Clean the water drain valve (with water filter) with a brush under running water.
5. Replace the water drain valve (with water filter) and close the drain plugs.  
(Take care not to lose the packing.)
6. Plug back the power cord and press the power button to power the unit on and check that water does not leak from the drain plugs or water drain valve (with water filter) and readjust the clock time. (→ p. 13)

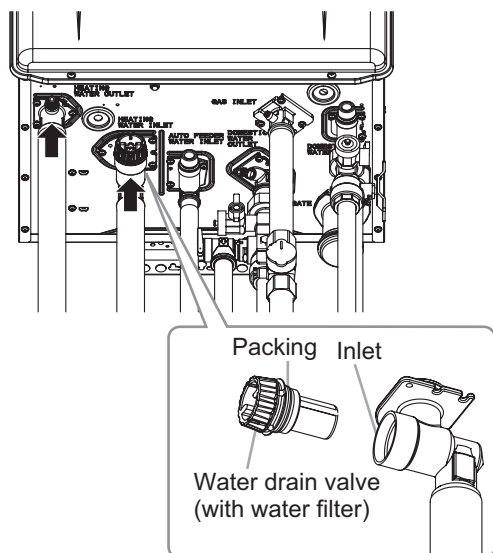

\* If it is difficult to remove the heating water inlet drain plug:

Use a needle-nose pliers and insert the tips of pliers into the holes or space shown below illustration.

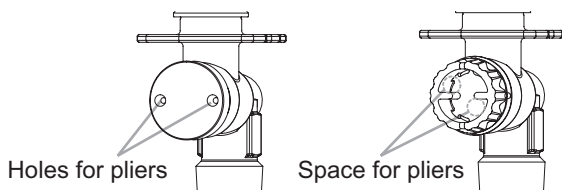

### When Using Anti-Freeze

- Anti freeze products may be used for the heating system. Anti freeze for new or existing systems requires specially formulated glycol, which contains inhibitors to prevent the glycol from attacking the metallic system components.
- Before using anti freeze products, ensure that system fluid contains proper glycol concentration and the inhibitor level is appropriate. Noritz recommends against exceeding a 50% concentration of glycol.
- When using the anti freeze products, the system must be tested at least once a year, and as recommended by the manufacturer of the glycol solution.

## Water Quality and Maintenance

For people who live in a hard water area, periodical flushing is necessary. If the Heat Exchanger is not flushed, Scale Build-up may cause damage to the Heat Exchanger. When the Heat Exchanger needs to be flushed to prevent damage from Scale Build-up. Contact Noritz America for more information about flushing the Heat Exchanger. (<http://support.noritz.com/> or 866-766-7489)

Damage to the Combi Boiler as a result of below is not covered by the Noritz America Limited Warranty. To ensure full warranty coverage, treat or condition water that exceeds the target levels provided in this table.

- Hard water
- Poor water quality (See the below list.)

Total Hardness**	: 200 mg/L (12 gpg) or less
Aluminum	: 0.05 to 0.2 mg/L or less
Chloride	: 250 mg/L or less
Copper	: 1 mg/L or less
Iron	: 0.3 mg/L or less
Manganese	: 0.05 mg/L or less
pH	: 6.5 - 8.5
Total Dissolved Solids	: 500 mg/L or less
Zinc	: 5 mg/L or less
Sulfate ion	: 250 mg/L or less
Residual chlorine	: 4 mg/L or less

\*\* Maximum limit suggested by Noritz.

Source: EPA National Secondary Drinking Water Regulations (40 CFR Part 143.3)

### Isolation Valves

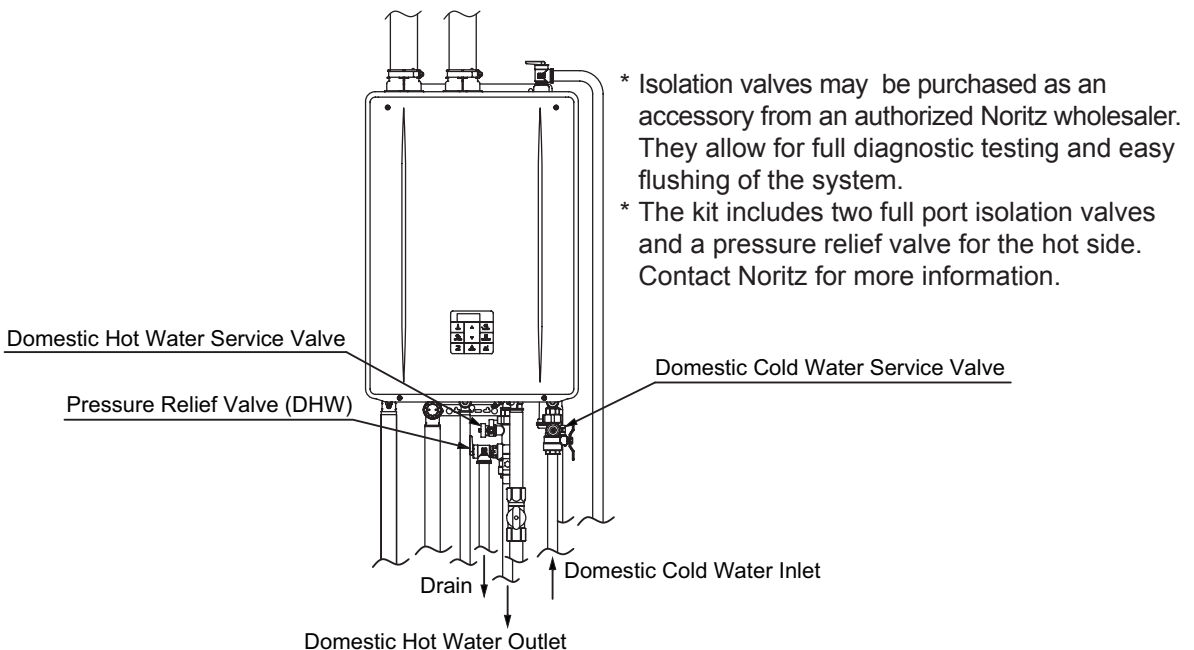

# Troubleshooting-1

## Initial Operation

Unit does not attempt to ignite when water is running.	<ul style="list-style-type: none"> <li>• Check for reversed plumbing or crossed pipes.</li> <li>• Check the water drain valve filter. (☞ p.29, p.30)</li> </ul>
Unit attempts to ignite but fails	<ul style="list-style-type: none"> <li>• Reset unit and try again. There may be air in the gas line.</li> <li>• Have a professional check the gas supply pressure.</li> </ul>

## DHW Temperature

DHW is not available when a fixture is opened.	<ul style="list-style-type: none"> <li>• Are the gas and water supply valves fully open?</li> <li>• Is the water supply cut off?</li> <li>• Is the hot water fixture/faucet sufficiently open?</li> <li>• Is the gas being cut off by the gas meter? (Can other gas devices such as stoves be used?)</li> <li>• (For LP) Is there enough gas in the tank? (Can other gas devices such as stoves be used?)</li> <li>• Is the water drain valve filter clogged? (☞ p.29)</li> <li>• Is the power button turned on?</li> <li>• Can the sound of the pump be heard? If not, there may be a malfunction. Contact your installer or a qualified service technician.</li> </ul>
No DHW is available when a fixture is opened.	<ul style="list-style-type: none"> <li>• Is the water supply cut off?</li> <li>• Is the heater frozen?</li> </ul>
The DHW is not the correct temperature.	<ul style="list-style-type: none"> <li>• Is the hot water fixture/faucet sufficiently open?</li> </ul>
Water takes time to become hot when turning the hot water fixture/faucet.	<ul style="list-style-type: none"> <li>• Have you allowed enough time for the cold water in the pipes to drain out?</li> </ul>
The water is too hot.	<ul style="list-style-type: none"> <li>• Are the gas and water supply valves fully open?</li> <li>• Is the water temperature setting appropriate? (☞ p.14)</li> <li>• If the water supply temperature is high, it is possible for the temperature to be higher than the temperature set on the Operation Panel.</li> <li>• If only a small amount of hot water is demanded, it is possible for the temperature to be higher than the temperature set on the Operation Panel.</li> </ul>
The DHW is not hot enough.	<ul style="list-style-type: none"> <li>• Are the gas and water supply valves fully open?</li> <li>• Is the water temperature setting appropriate? (☞ p.14)</li> <li>• If the amount of hot water required is very high, it is possible for the temperature to be lower than the temperature set on the Operation Panel. Decrease the amount of hot water passing through the unit and the temperature should stabilize.</li> </ul>



(Continued)

The DHW is cold when only a single fixture is open.	<ul style="list-style-type: none"><li>• The unit will not heat the water if the flow rate is less than 0.4 gallons (1.5L) per minute.<ul style="list-style-type: none"><li>* Minimum activation flow rate : 0.4 GPM (1.5L/min)</li><li>Minimum operating flow rate : 0.29 GPM (1.1L/min)</li></ul></li><li>• Open the fixture more or open other fixtures so that a greater flow passes through the unit, and the unit should begin heating again.</li></ul>
Fluctuations in DHW temperatures.	<ul style="list-style-type: none"><li>• Set water temperature at 115°F to 120°F or 48°C (118°F) to 50°C (122°F). This will allow you to use a higher flow of hot water thus meeting the minimum flow requirement of 0.29 GPM (1.1L/min.).<ul style="list-style-type: none"><li>* Minimum activation flow rate : 0.4 GPM (1.5L/min)</li><li>Minimum operating flow rate : 0.29 GPM (1.1L/min)</li></ul></li><li>• Clean the water filter of any debris. (☞ p.29)</li></ul>
DHW temperature setting cannot rise.	<ul style="list-style-type: none"><li>• Is the maximum temperature setting appropriate? (☞ p.20)</li></ul>

## Amount of DHW

The amount of DHW at a certain fixture is not constant.	<ul style="list-style-type: none"><li>• When hot water is demanded at other fixtures, the amount available may be reduced. The maximum flow available from NRCB199DV (GHQ-C3201WX-FF US) and NRCB180DV(GHQ-C2801WX-FF US) are 8.4 GPM (32L/min.) and 7.5GPM (28.2L/min.), respectively at a 45°F (25°C) temperature rise.</li><li>• Pressure fluctuations and other plumbing conditions can cause the temperature and pressure at a fixture to be unstable, but it should stabilize after a short time.</li><li>• There are some types of hot water taps that discharges large volumes of hot water at first but stabilize after time.</li><li>• To keep the temperature stable, the heater limits the amount of water that can flow through it to a small amount initially, but the amount increases over time.</li></ul>
Amount of DHW available has decreased over time.	<ul style="list-style-type: none"><li>• Is the water filter clogged? (☞ p.29)</li><li>• If the supply water is hard and has not been treated, scale can build-up in the Combi Boiler and decrease the maximum amount of hot water available. Scale can be removed from the Combi Boiler by flushing the unit periodically. To prevent scale from forming in the Combi Boiler, a water softener or scale inhibitor is recommended.</li></ul>

# Troubleshooting-2

## Operation Panel

<p>The power ON/OFF indicator does not light up.</p>	<ul style="list-style-type: none"> <li>• Has there been a power failure?</li> <li>• Is the power connected properly?</li> </ul>
<p>The clock display shows "- : - -".</p>	<ul style="list-style-type: none"> <li>• If the time has not been set, The clock display shows "- : - -". (☞ p.13)</li> </ul>
<p>The temperature setting cannot be changed when a button is pressed.</p>	<ul style="list-style-type: none"> <li>• The temperature setting is locked. While the temperature setting is locked, the temperature setting cannot be changed. (☞ p.21)</li> </ul>
<p>The clock display is blinking.</p>	<ul style="list-style-type: none"> <li>• In the event of a power outage or after disconnecting power to the Combi Boiler, when power is restored the clock time will blink.</li> <li>• If you find the clock blinking, readjust the clock. (☞ p.13)</li> </ul>



## Heating

<p>The room does not get warm. The heating does not operate.</p>	<ul style="list-style-type: none"> <li>• Is the gas valve, return valve and supply valve fully open?</li> <li>• Is the gas being cut off by the gas meter? (Can other gas devices such as stoves be used?)</li> <li>• (For LP) Is there enough gas in the tank? (Can other gas devices such as stoves be used?)</li> <li>• Is the water drain valve filter clogged with debris? (☞ p.30)</li> <li>• Is the power button turned on?</li> <li>• Is the heating switch of a room thermostat turned on?</li> <li>• Can the sound of the pump be heard? If not, there may be a malfunction. Contact your installer or a qualified service technician.</li> <li>• Increase heating temperature setting.</li> </ul>
--	--

## Sounds

<p>The fan can be heard after operation is stopped. A motor can be heard when turning the unit ON or OFF, when opening or closing a fixture, or after the unit has been running for a while.</p>	<ul style="list-style-type: none"> <li>• These noises indicate the proper operation of devices which are designed to let the unit reignite more quickly, and ensure the water temperature is stable.</li> </ul>
<p>The fan can be heard when it is very cold outside.</p>	<ul style="list-style-type: none"> <li>• The unit may operate freeze prevention. During freeze prevention, ❄️ is lit on the Operation Panel.</li> </ul>
<p>Rotating sound. (low humming sound.)</p>	<ul style="list-style-type: none"> <li>• The sound is from the pump operating to prevent freezing.</li> <li>• The unit automatically operates the pump for several seconds when the unit has not been used for approximately 30 days to prevent the pump from malfunctioning due to build-up of deposits.</li> </ul>

## Other

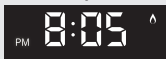
<p>The Combi Boiler stops burning during operation.</p>	<ul style="list-style-type: none"> <li>• Are the gas and water supply valves fully open?</li> <li>• Is the water supply cut off?</li> <li>• Is the hot water fixture/faucet sufficiently open?</li> <li>• Is the gas being cut off by the gas meter? (Can other gas devices such as stoves be used?)</li> <li>• (For LP) Is there enough gas in the tank? (Can other gas devices such as stoves be used?)</li> <li>• When the heating supply temperature is too high, the unit will stop burning.</li> </ul>
<p>White smoke comes out of the exhaust vent on a cold day.</p>	<ul style="list-style-type: none"> <li>• This is normal. The white smoke is actually steam.</li> </ul>
<p>The DHW is turbid.</p>	<ul style="list-style-type: none"> <li>• This is harmless. Small bubbles appear as the air in the water is heated and depressurized rapidly to atmospheric pressure.</li> </ul>
<p>The water appears blue The bath tub/wash-basin has turned blue</p>	<ul style="list-style-type: none"> <li>• Coloration to a blue color may be noticed from small traces of copper ion contained in the water and fat (furring). However, there are not problems concerning health. Coloration of the bath tub/wash-basin can be prevented by cleaning frequently.</li> </ul>
<p>Frequent water discharge from the drain pipe.</p>	<ul style="list-style-type: none"> <li>• Condensation forms inside the unit during operation and is discharged from the drain pipe.</li> </ul>
<p>A small amount of water is discharged from the pressure relief valve.</p>	<ul style="list-style-type: none"> <li>• This is normal. When the Combi Boiler is under high pressure, a small amount of water may be discharged from the pressure relief valve.</li> </ul>
<p>The Combi Boiler water is leaking from the safety relief valve.</p>	<ul style="list-style-type: none"> <li>• There is a possibility that air is leaking from the expansion tank. Contact your installer or a qualified service technician.</li> </ul>
<p> is blinking</p>	<ul style="list-style-type: none"> <li>• This is normal. This shows disconnecting the outdoor sensor. (→p.16)</li> </ul>
<p>The screen display shows</p>  <p>(The Burner ON Icon is lit without DHW Icon or Heating Icon.)</p>	<ul style="list-style-type: none"> <li>• When DHW Wait Time is operating, the screen display occasionally shows</li> </ul> 

# Troubleshooting-3

## Check for an Error Code Display on the Operation Panel

If there is a problem with the unit, a numerical error code will flash on the Operation Panel. If this occurs, take appropriate measures as listed below.

When an error code appears, the display and the operation light will flash together.

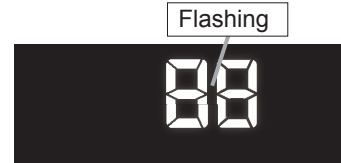

Screen Display

Error Code	Cause	Action
11	Ignition error	Check whether the gas valve is open. Press the power button to turn the unit off, open a hot water fixture, and turn the unit back on. If the flashing number doesn't return the problem is solved.
20	High Limit Switch - Primary Heat Exchanger triggered	Check for air in the heating system or air lock of internal pump. DO NOT ignore this condition. Failure to properly remove air from the heating system will cause this error to continuously appear and potentially damage the Heat Exchanger.
64	Internal Pump Abnormal (Air Lock of Internal Pump)	Check for air in the heating system or air lock of internal pump. The internal pump may be locked by air and then can not supply water to the Heat Exchanger. DO NOT ignore this condition. Failure to properly remove air from the heating system will cause this error to continuously appear and potentially damage the Heat Exchanger.  This error code will continue to be displayed (warning indication only) on the Operation Panel after reconnecting power. To clear this error code, contact the nearest Noritz agent.
88	Service Reminder (Warning Indication)	This unit is equipped with an automatic service reminder. If the display shows "88", contact the nearest Noritz agent.
90	[When supplying combustion air from the indoors] The air supply vent may be clogged.	Check air supply vent for blockage or obstruction. (👉 p.28)
	Exhaust vent may be clogged.	Check exhaust vent for blockage or obstruction.
	Abnormal combustion, low gas supply pressure.	Have a professional check the gas supply pressure.
	Condensate drain line may be clogged.	Check condensate drain line is clogged or frozen. If the display continues, contact the nearest Noritz agent.

**Contact Noritz America if:**

- Any other error code appears.
- An error code is indicated again after the above actions were followed.
- There are any other questions.

# Follow-up Service-1

## Requesting Service

First follow the instructions in the troubleshooting section ( p.32 to p.36).  
If the error is not corrected, contact Noritz America Technical Support at 866-766-7489.

We will need to know:

**The Model** .....(check the rating plate)

\*See p.4 for the location of the label

**Date of purchase** .....(see the warranty)

**Details of problem** ....(flashing error codes,  
etc., in much detail as possible)

**Your name, address, and telephone number**

**Desired date of visit**



\* A request for service may be rejected if the Combi Boiler is installed in a location where working on the unit may be dangerous. Contact a professional.

## Warranty

A warranty registration card is included separately.

Be sure that the installer name, date of purchase and other necessary items are filled in.  
Read the content carefully, and keep the warranty card in a safe place.

For repairs after the warranty period, there will be a charge on any service, and service will only be performed if the unit is deemed repairable.

## Period of Time for Stocking Repair Parts

Noritz will stock repair and maintenance parts for this unit within ten (10) years of the date of the original installation.

## Reinstallation

If you want to reinstall the appliance at a different location, confirm that the gas and power supply indicated on the rating plate are available at the new location. If you are not sure, consult the local utility company.

# Follow-up Service-2

## Gas Conversion

If you move to a region that uses a different type of gas or if the local gas supply is converted, replacement of the gas manifold and adjustment of the appliance will be necessary.

This work must be performed by either Noritz or a qualified service agency and will be charged for even during the warranty period. The qualified installer will also be responsible for purchasing the gas conversion kit directly from the manufacturer.

For more information, contact Noritz America Technical Support at 866-766-7489.

### **WARNING**

The gas conversion kit shall be installed by a qualified service agency\* in accordance with the manufacturer's instructions and all applicable codes and requirements of the authority having jurisdiction. The information in the instructions must be followed to minimize the risk of fire or explosion or to prevent property damage, personal injury, or death. The qualified service agency is responsible for the proper installation of this kit. The installation is not proper and complete until the operation of the converted appliance is checked as specified in the manufacturer's instructions supplied with the kit.

\* A qualified service agency is any individual, firm, corporation, or company which either in person or through a representative is engaged in and is responsible for the connection, utilization, repair or servicing of gas utilization equipment or accessories; who is experienced in such work, familiar with all precautions required, and has complied with all of the requirements of the authority having jurisdiction.

Before the gas conversion is performed, verify the proper gas conversion kit with your Combi Boiler model on the table provided below.

Conversion Kit	Model	Conversion Type
CK-75	NRCB199DV(GHQ-C3201WX-FF US)	Propane to Natural Gas
CK-76		Natural Gas to Propane
CK-77	NRCB180DV(GHQ-C2801WX-FF US)	Propane to Natural Gas
CK-78		Natural Gas to Propane

The following parts are supplied in the conversion kit. These items will replace the existing parts that are currently installed in the unit. Make sure that all parts are replaced and properly installed by a qualified service agency.

\* An Operation Panel and a digital gas manometer are required to complete the installation. Do not proceed if this equipment is not immediately available.

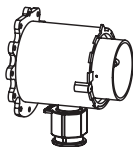

Venturi Mixer Set



O-Ring × 2



Conversion Kit Label

After the necessary parts have been replaced on the unit, the Operation Panel is then used to adjust the settings on the Combi Boiler for use with the proper gas type.

The following pressure values are verified by the installer.

- The inlet gas pressure value at the gas supply inlet fitting
- The offset pressure value at the gas valve

Proper adjustments will be made to ensure safe and efficient operation.

Once this is completed, a final gas leak check will be performed to confirm that all parts have been securely installed.

If you notice the smell of gas at any time after the installation has been completed, turn the Combi Boiler off and contact your gas supplier immediately.

# Specifications-1

- Specifications may be changed without prior notice.
- The capacity may differ slightly, depending on the water pressure, water supply, piping conditions, and water temperature.

## Specifications

Item		Specification	
Model Name		NRCB199DV(GHQ-C3201WX-FF US)	NRCB180DV(GHQ-C2801WX-FF US)
Type	Installation	Indoor / Outdoor Wall mounted	
	Air Supply/Exhaust	Power Vented	
Ignition		Direct Ignition	
Operating Pressure	DHW	15-150 psi (Recommended 30 psi or more for maximum performance)	
	Heating	12-30 psi	
Minimum Flow Rate		0.4 GPM (1.5L/min)	
Minimum Operating Flow Rate*		0.29 GPM (1.1L/min)	
Dimensions (Height) x (Width) x (Depth)		27.0" (687mm) x 18.5" (471mm) x 12.8" (325mm)	
Weight		95 lbs.	
Pressure Relief Valve Setting	Heating	30 psi	
Connection Sizes	DHW Cold Water Inlet	NPT 3/4"	
	DHW Outlet	NPT 3/4"	
	Heating Supply	NPT 1"	
	Heating Return	NPT 1"	
	Heating Pressure Relief Valve	NPT 3/4"	
	Auto Feeder Inlet	NPT 1/2"	
	Gas Inlet	NPT 3/4"	
	Condensate Drain	NPT 1/2"	
Power Supply	Supply	120 VAC (60Hz)	
	Consumption	NG : 210W LP : 210W Freeze Prevention 125W	NG : 200W LP : 200W Freeze Prevention 125W
Materials	Casing	Front Cover, Side/Top Plate : Hot-dipped zinc-aluminum-magnesiumalloy-coated steel w/ Polyester Coating Back Plate : Hot-dipped zinc-aluminum-magnesiumalloy-coated steel w/o Coating Bottom Plate : Zincified Steel Plate/Polyester Coating	
	Flue Collar	PP	
	Primary Heat Exchanger	Stainless Steel : 316L	
	Secondary Heat Exchanger	Stainless Steel : 316L	
Safety Devices		Flame Rod, High Limit Switch, Lightning Protection Device (ZNR), Freezing Prevention Device, Fan Rotation Detector	
Accessories		Anchoring Screws, Wall Mounting Bracket, Outdoor Temperature Sensor, Anchoring Screws & Anchors for Outdoor Temperature Sensor	

\* Minimum operating flow rate may change by setting temperature and water temperature.

# Specifications-2

- Specifications may be changed without prior notice.
- The capacity may differ slightly, depending on the water pressure, water supply, piping conditions, and water temperature.

## Performance

Item			Performance	
Model Name			NRCB199DV(GHQ-C3201WX-FF US)	NRCB180DV(GHQ-C2801WX-FF US)
Gas Consumption	DHW	NG	Maximum Performance 199,900 btuh	Maximum Performance 180,000 btuh
			Minimum Performance 18,000 btuh	Minimum Performance 18,000 btuh
		LP	Maximum Performance 199,900 btuh	Maximum Performance 180,000 btuh
			Minimum Performance 18,000 btuh	Minimum Performance 18,000 btuh
	Heating	NG	Maximum Performance 120,000 btuh	Maximum Performance 100,000 btuh
			Minimum Performance 18,000 btuh	Minimum Performance 18,000 btuh
		LP	Maximum Performance 120,000 btuh	Maximum Performance 100,000 btuh
			Minimum Performance 18,000 btuh	Minimum Performance 18,000 btuh
Maximum Hot Water Capacity		45°F (25°C) Rise	8.4 GPM (32 L/min.)	7.5 GPM (28.2 L/min.)
Capacity Range			0.4-11.1 GPM (1.5-42 L/min.)	0.4-9.8 GPM (1.5-37 L/min.)
Temperature Settings	DHW*	°F Mode	90-140°F (In 5°F intervals) (11 Options)	
		°C Mode	32°C,35°C,37°C-48°C (In 1°C intervals),50°C,55°C,60°C (17 Options)	
	Heating	°F Mode	100-180°F (In 1°F intervals) (81 Options)**	
		°C Mode	40-82°C (In 1°C intervals) (43 Options)**	

\* When you use Quick Connect Multi System, temperature setting range is changed below.

°F Mode : 100-140°F (In 5°F intervals)

°C Mode : 37 - 48°C (In 1°C intervals), 50°C,55°C,60°C

\*\* Heating Temperature range depends on Installer Mode Setting.

Refer to the Installation Manual for details.

## Space Heating Rating

Noritz Combination Boiler Space Heating Ratings						
Model Number		Input, MBH		Heating Capacity, MBH <sup>1</sup>	Net AHRI Rating Water, MBH <sup>2</sup>	AFUE, %
		Min	Max			
NRCB199DV (GHQ-C3201WX-FF US)	NG	18	120	111	97	95.0
	LP	18	120	111	97	95.0
NRCB180DV (GHQ-C2801WX-FF US)	NG	18	100	92	80	95.0
	LP	18	100	92	80	95.0

<sup>1</sup> Based on standard test procedures prescribed by United States Department of Energy (DOE).

<sup>2</sup> The Net AHRI water ratings shown are based on a piping and pickup allowance of 1.15.

Consult Noritz before selecting a boiler for installations having unusual piping and pickup requirements, such as intermittent system operation, extensive piping system, etc.