

**STRAIGHT-ANGLE
PATTERN**

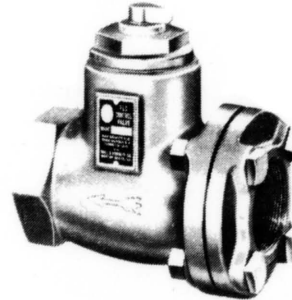

**BRONZE STRAIGHT
PATTERN**



STRAIGHT PATTERN

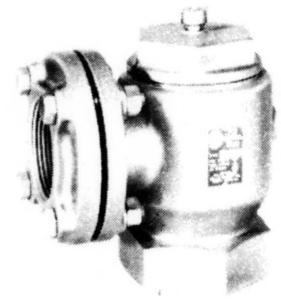

ANGLE PATTERN

Flo- Control Valves

INSTALLER: PLEASE LEAVE THIS MANUAL FOR THE OWNER'S USE.

DESCRIPTION

Bell & Gossett Flo-Control Valves are used for preventing gravity flow in forced water systems and to permit summer-winter operation of indirect water heaters. Flo-Control Valves in NPT sizes 3/4" to 2" are made in combination straight-angle patterns permitting installation in either horizontal or vertical pipes. Larger sizes are furnished in either straight or angle patterns.



WARNING: Potential solder joint failure. You must comply with the limits of temperature, pressure and solder type listed in Chart A. Failure to follow these instructions could result in serious personal injury or death and property damage.



SAFETY INSTRUCTION

This safety alert symbol will be used in this manual and on the Flo-Control Valve safety instruction decal to draw attention to safety related instructions. When used, the safety alert symbol means ATTENTION! BECOME ALERT! YOUR SAFETY IS INVOLVED! FAILURE TO FOLLOW THE INSTRUCTIONS MAY RESULT IN A SAFETY HAZARD.

CHART A
WORKING PRESSURE & TEMPERATURE LIMITS
(Solder Type Limits Per ASTM Std. B16.18-1978)

Flow-Control Style	Type of Solder	Maximum Limitations	
		Pressure PSI	Temperature °F
NPT	-	125	250
Screwed and Flanged Ends	-	125	250
Sweat	95-5 Tin-Antimony	125	250

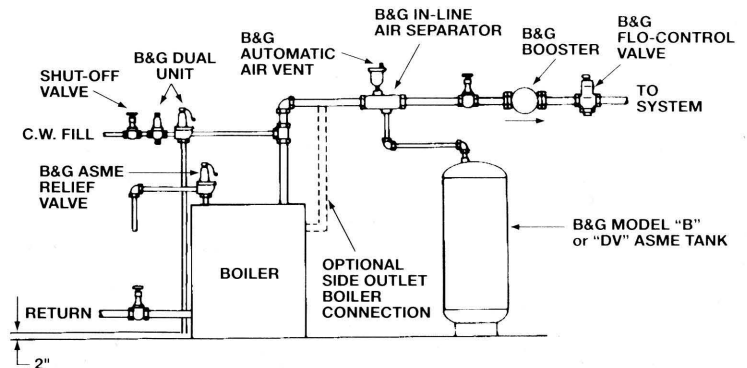

B&G FLO-CONTROL VALVE STRAIGHT ANGLE PATTERN WITH NPT CONNECTION

This valve can be installed with bottom or side inlet. The stem must be in the top vertical position.

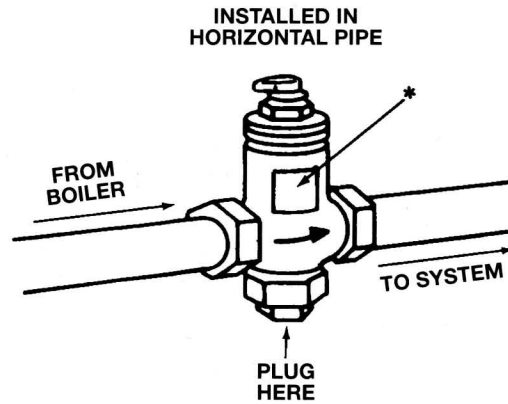
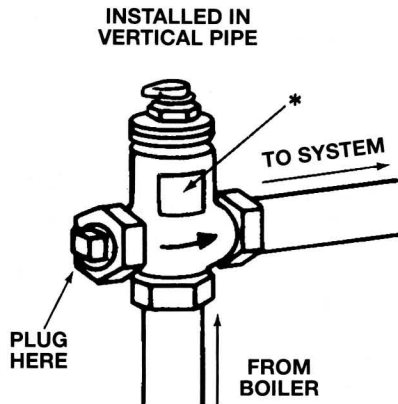

B&G FLO-CONTROL VALVE STRAIGHT PATTERN WITH SWEAT CONNECTION

The stem must be in the top vertical position.

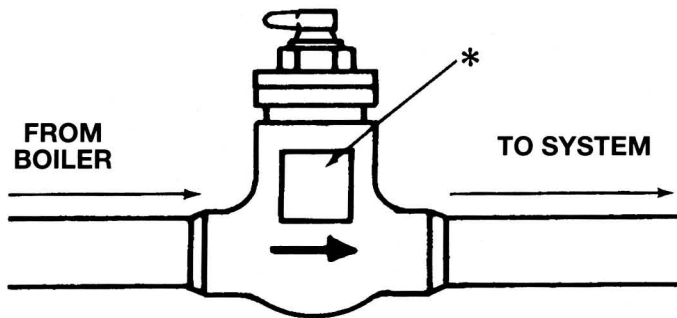

INSTALLED IN HORIZONTAL PIPE

*Warning label installed per Table #1

B&G FLO-CONTROL VALVE STRAIGHT PATTERN WITH FLANGED CONNECTION

The stem must be in the top vertical position.

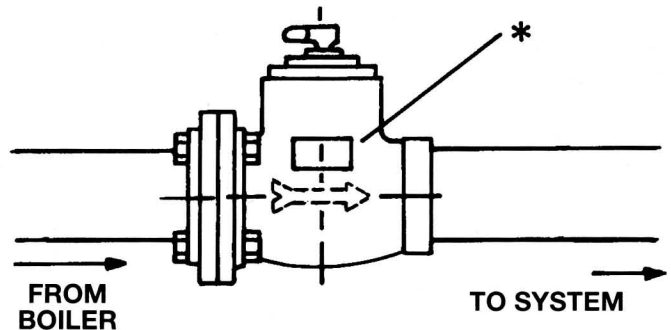

INSTALLED IN HORIZONTAL PIPE

TABLE #1

Model No.	Warning Label Location
A2 ¹ / ₂ , A3, SB ³ / ₄ , SA ³ / ₄	Flow arrow side
S2 ¹ / ₂ , S3, S4, SA1, SA1 ¹ / ₂ , SA2	Side opposite flow arrow

Warning Label Part No. V56871 must be replaced if missing. If the sweat connection model is used, THE INSTALLER IS TO APPLY THE WARNING LABEL ON THE ARROW SIDE AND THE NAMEPLATE ON THE OPPOSITE SIDE AFTER SOLDERING IN THE PIPING.

INSTALLATION INSTRUCTIONS

FLO-CONTROL VALVE WITH NPT AND FLANGED CONNECTION

1. Install the valve with the arrow on the body stem in the direction of flow. The Flo-Control valve stem must be in the top vertical position.

CAUTION: The generous use of pipe joint compound when installing the Flo-Control valve will foul the valve operating mechanism preventing it from functioning properly. Pipe joint compound must be conservatively applied to male threads only. Failure to follow these instructions could result in moderate personal injury or property damage.

CAUTION: The use of PTFE impregnated pipe compound and PTFE tape on pipe threads provide lubricity which can lead to overtightening and breakage. Do not overtighten. Failure to follow these instructions could result in moderate personal injury or property damage.

2. Flo-Control models with a flanged connection are to be installed with a companion flange, gasket and bolting supplied with Flo-Control.

WARNING: Flange joints leaking high temperature fluids can result from improperly installed gaskets. Use only the size and type bolts, gaskets and flange supplied with Flo-Control. Bolts must be properly torqued and tightened in a criss-cross pattern. Failure to follow these instructions could result in serious personal injury or death and property damage.

3. See installation drawings for additional information.

FLO-CONTROL VALVE WITH SWEAT CONNECTION

1. Install the valve in horizontal piping so that the valve stem is in the top vertical position and the arrow on the body is in the direction of flow.
2. Refer to Chart A for the maximum operating pressure and temperature based on the type of solder used.

CAUTION: The high temperature required to silver solder the Flo-Control into the system can damage Flo-Control valve. Do not use silver solder. Chart A gives recommendations for solder that can be used. Failure to follow these instructions could result in moderate personal injury or property damage.

CAUTION: Excessive heat during soldering can damage the Flo-Control and gasket resulting in leakage problems. Apply only the heat necessary to melt the solder and make a good solder joint. Failure to follow these instructions could result in moderate personal injury or property damage.

3. After sweating the joints, check the connections for leakage by pressurizing system.
4. Allow the valve body to cool below 100°F before installing the nameplate and warning label to the valve body. See installation drawings for location.
5. See installation drawings for additional information.

OPERATING INSTRUCTIONS

Flo-Control Valves are vertical lift check valves that function when the system pump starts. Flo-Control Valves are designed with a handle that when turned fully counterclockwise will permit gravity circulation. This is useful in emergency situations whenever electrical power is lost and only partial heating is possible.

During system filling and purging it may be helpful to manually open the Flo-Control Valve to aid in air removal. Do this by turning the handle counterclockwise to the fully open position.

IMPORTANT: If handle is left in the manual open position, uncontrolled heating of room radiation will occur. If after power outage or system air venting the manual flow feature was used, make sure the Flo-Control is returned to automatic operation.

SERVICE INSTRUCTIONS – FLO-CONTROL VALVE

WARNING: Corrosion or leakage are indications that the Flo-Control Valve may be about to cause serious damage from leakage or rupture. It must be periodically inspected and if noted, the Flo-Control must be serviced or replaced. Failure to follow these instructions could result in serious personal injury or death and property damage.

- A. If the Flo-Control Valve is leaking at the packing nut, turn the packing nut clockwise until the leak stops.

WARNING: Hot leaking fluids can cause burns or other injury. Avoid contact with leaking fluids. Failure to follow these instructions could result in serious personal injury or death and property damage.

- B. If packing nut leaking persists, follow the procedure noted below:

1. Isolate the Flo-Control Valve from the system with shut-off valves, or drain the system.

2. If isolation valves are used, vent the pressure from the Flo-Control Valve by opening a drain valve. Make sure the system pressure is zero and the system has cooled to 100°F or less. Leave the vents or drain open during servicing.

WARNING: System fluids under pressure or temperature can be very hazardous. Be sure the pressure has been reduced to zero, the system temperature is below 100°F, and the drain is left open during service. Failure to follow these instructions could result in serious personal injury or death and property damage.

3. Turn the Flo-Control handle to counterclockwise to the fully open position.
4. Remove the retainer ring, handle and packing nut.
5. Remove the old packing and repack with B&G preformed packing.
6. Replace the packing nut and tighten (as required).
7. Reassemble the handle and turn it fully clockwise.

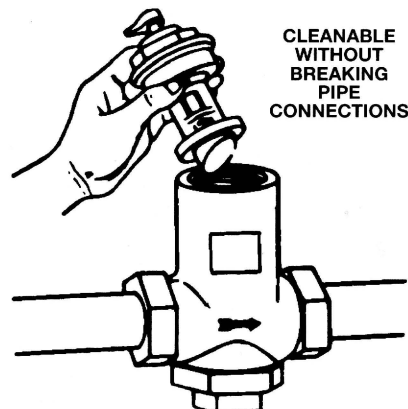
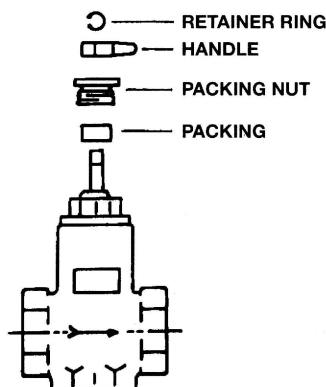

C. If the Flo-Control Valve fails to prevent gravity circulation, the gasket leaks, or there are other signs of leakage or corrosion, follow these steps.

1. Isolate the Flo-Control Valve from the system with shut-off valves, or drain the system.
2. Make sure the system pressure is zero, or if isolation valves are used, that the pressure in the Flo-Control is zero. Leave vents and drains open. Make sure the system has cooled to 100°F or less.



WARNING: System fluids under pressure or temperature can be very hazardous. Be sure the pressure has been reduced to zero, the system temperature is below 100°F, and the drain is left open during service. Failure to follow these instructions could result in serious personal injury or death and property damage.

3. Loosen the Flo-Control Valve cap by turning it counter-clockwise until the threads disengage. Remove the valve disc assembly.

4. A periodic inspection of the Flo-Control Valve internals and externals for signs of leakage, corrosion or erosion is recommended. If damaged, they must be replaced to function properly.
5. If the Flo-Control Valve appears to be in serviceable condition, clean the valve seat and the mating disc surfaces with a soft clean rag.
6. Replace the gasket before reassembling the disc and cap assembly. It is recommended that the gasket be replaced regardless of a lack of apparent damage.
7. Reassemble the Flo-Control Valve by replacing the valve disc and cap assembly, and tighten.
8. Return the system to its normal operating mode.
9. If leakage occurs at the cap gasket area, tighten (as required) until the leakage stops.



Xylem Inc.
8200 N. Austin Avenue
Morton Grove, Illinois 60053
Phone: (847) 966-3700
Fax: (847) 965-8379
www.xylem.com/brands/bellgossett