

## INSTRUCTIONS FOR INSTALLATION OF 184960 SERIES GAS CONTROL

### WARNING

THIS REPLACEMENT KIT SHALL BE INSTALLED BY A QUALIFIED SERVICE AGENCY IN ACCORDANCE WITH THE MANUFACTURER'S INSTRUCTIONS AND ALL APPLICABLE CODES AND REQUIREMENTS OF THE AUTHORITY HAVING JURISDICTION. THE INFORMATION IN THESE INSTRUCTIONS MUST BE FOLLOWED TO MINIMIZE THE RISK OF FIRE OR EXPLOSION AND PREVENT PROPERTY DAMAGE, PERSONAL INJURY OR DEATH. THE QUALIFIED SERVICE AGENCY IS RESPONSIBLE FOR THE PROPER INSTALLATION OF THIS KIT. THE INSTALLATION IS NOT PROPER AND COMPLETE UNTIL THE OPERATION OF THE CONVERTED APPLIANCE IS CHECKED AS SPECIFIED IN THE MANUFACTURER'S INSTRUCTIONS SUPPLIED WITH THE KIT.

### INTRODUCTION

These instructions are intended for the installation of the 184960 (series) gas control. The gas control that you are replacing is of either the 184960 Series or in some cases for conversion kits (from Propane gas to Natural gas) is the 183760 Series or the 184768 Series gas control. This thermostat kit alone is not the correct kit to change from the 183760 Series or the 184768 Series gas controls unless this thermostat kit is used as part of a master pack conversion kit (from LP to Nat.).

Note: Pictured illustrations in this instruction sheet may show gas control inlet at top or side. The Intelli-vent™ Thermostat Control, (183760 Series) has a top inlet gas piping connection and the Intelli-vent™ Thermostat Control, (184960 Series and 184768 Series) has a side inlet gas piping connection.

### IMPORTANT

The installation of this kit requires ability equivalent to that of a licensed tradesman in the field involved. Air supply, venting, gas supply and electrical work are required. These instructions as well as the manual that came with the water heater must be read thoroughly and understood before attempting to install this replacement kit.

All WARNINGS and CAUTIONS in both these instructions and the manual that came with the water heater must be carefully observed at all times.

### WARNING

Improper installation could result in a hazardous condition such as explosion or carbon monoxide poisoning resulting in serious personal injury or death.

### PREPARATION

Before beginning the installation, do the following:

1. Shut off the gas supply to the water heater.
2. Toggle the "ON/OFF" switch on the blower control box to the "OFF" position.

3. Turn off and disconnect all electrical power to the water heater.
4. Close the cold water supply valve to the water heater.
5. Attach a hose to the drain valve on the water heater. The drain valve has threads on the end that will allow the connection of a standard hose coupling.
6. Open the drain valve on the water heater by turning the knob counter-clockwise . BE CAREFUL TO GRASP THE DRAIN VALVE HANDLE SO THAT YOUR HAND IS NOT EXPOSED TO HOT WATER. IF DESIRED, A HOSE MAY BE CONNECTED TO THE DRAIN VALVE TO CARRY THE WATER AWAY.

### DANGER: The water MAY BE HOT

7. Open a hot water faucet to allow air to enter the system.
8. Allow water to completely drain from the water heater.

After the above steps have been conducted, the water heater is ready for installation of the thermostat kit.

### INSTALLATION

Tools Required For Replacement:

The following minimum tools are required to properly install the 184960 Series thermostat kit.

- Drain Hose
- 3/4 inch Open-End Wrench
- Suitable length of threaded 1/2 inch diameter pipe (Needed to remove and install the thermostat controls.)
- Proper size pipe fitting(s) to cap off the gas supply line
- Philips Head Screwdriver
- Pipe Wrench
- Soap & Water Solution w/Brush or Commercial Leak Detector Fluid
- Approved Gas Pipe Sealant Compound



All piping must comply with local codes or, in the absence of local codes the *National Fuel Gas Code, ANSI Z223.1/NFPA 54 and/or B149.1 Natural Gas and Propane Installation Codes.*

1. Make sure that the electrical power to the water heater is turned off and disconnected. Also make sure the gas supply to the water heater is shut off.
2. Locate the wiring harness and connector that comes out of the water heater's jacket and is plugged into the Intelli-vent™ Thermostat Control. Squeeze the connector and pull it straight out of the control, see Figure 1.
3. Locate the ignitor assembly and connector that comes out of the combustion chamber of the water heater and is plugged into the Intelli-vent™ Thermostat Control. Squeeze the connector and pull it straight out of the control, see Figure 1.

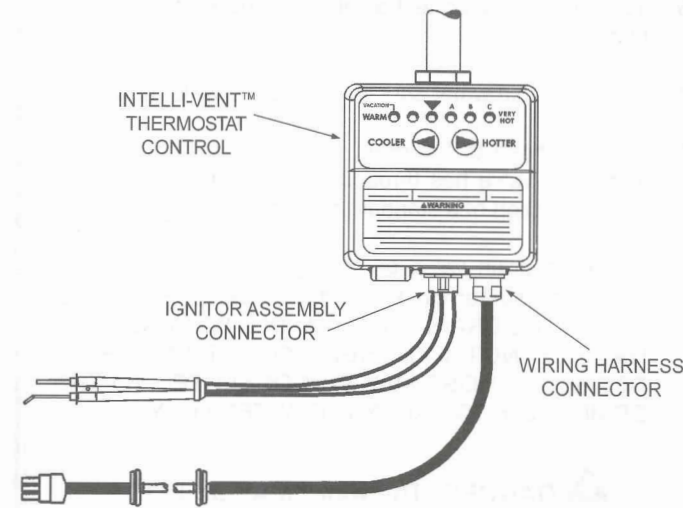

FIGURE 1.

4. Using a 3/4 inch open-end wrench, disconnect the burner tube's inverted flare nut, which is threaded into the Intelli-vent™ Thermostat Control, see Figure 2.
5. Remove the outer and inner doors from the water heater, see Figures 2 and 3.

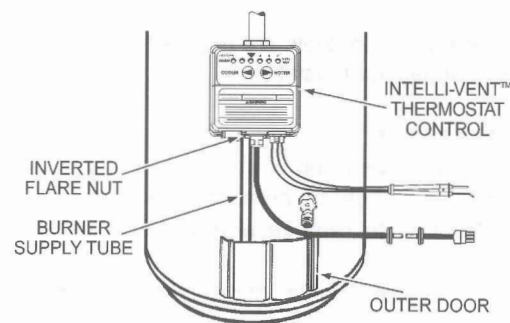

FIGURE 2

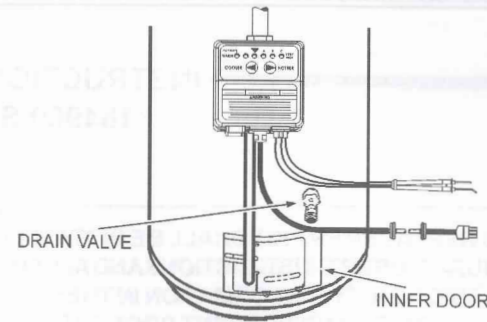

FIGURE 3.

6. Remove the burner assembly from the water heater, see Figure 4.

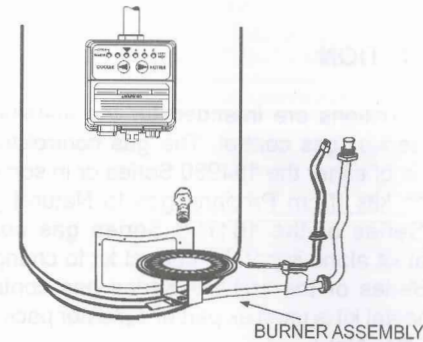

FIGURE 4

7. Disconnect the gas supply piping to the water heater preferably at the ground joint union (if installed), see Figure 5.
8. Disconnect all the piping from the Intelli-vent™ Thermostat Control, see Figure 5.
9. Thread a straight section of 1/2 inch diameter pipe into Intelli-vent™ Thermostat Control, see Figure 6.
10. Using your hand, grasp the straight pipe attached to the Intelli-vent™ Thermostat Control, and rotate it counter-clockwise until the valve is fully disconnected from the water heater, see Figure 7.

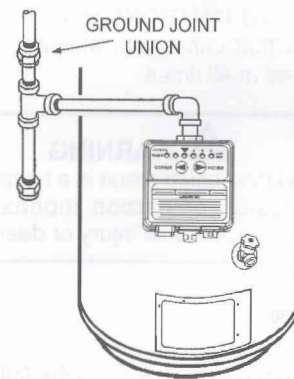

FIGURE 5.

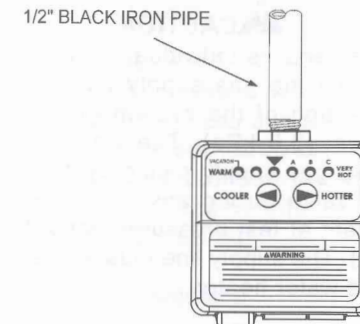

FIGURE 6.

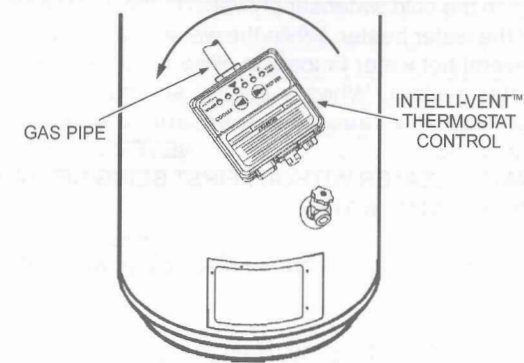

FIGURE 7.

11. Hand start threading the Intelli-vent™ Thermostat Control, (184960 Series) into the water heater by rotating it clockwise. Continue to rotate the control until it is snug.
12. Un-thread and remove the straight section of 1/2 inch diameter pipe that is attached to the Intelli-vent™ Thermostat Control being replaced and thread the pipe into the Intelli-vent™ Thermostat Control, (184960 Series), see Figure 8.

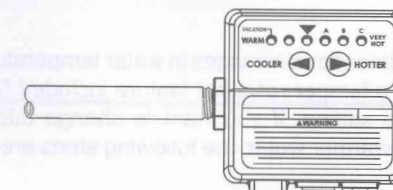

FIGURE 8.

13. Using your hand, grasp the straight pipe attached to the Intelli-vent™ Thermostat Control, (184960 Series) and rotate it clockwise until the control is tight and aligned correctly, see Figure 9.
14. Connect gas piping to the Intelli-vent™ Thermostat Control, (184960 Series) and only to the type of gas (i.e. Natural or Liquefied Petroleum/ LP gases, Propane gas) as shown on the rating plate. Use only clean 1/2 inch black iron pipe. (Dirt and scale from the pipe can enter the control and cause it to malfunction). The inlet gas line must have a drip leg (sediment trap) installed as close as possible to Intelli-vent™ Thermostat Control, (184960 Series) having a minimum length of three (3) inches (7.6 cm). A ground joint union must be installed in the gas supply line feeding the water heater to permit servicing, of the water heater, see Figure 10. Joints shall be made using approved gas pipe joint compound on

the male pipe thread ends. Pipe joint compound must be resistant to the action of Liquefied Petroleum/ LP gases, Propane gas. Do not use Teflon Tape.

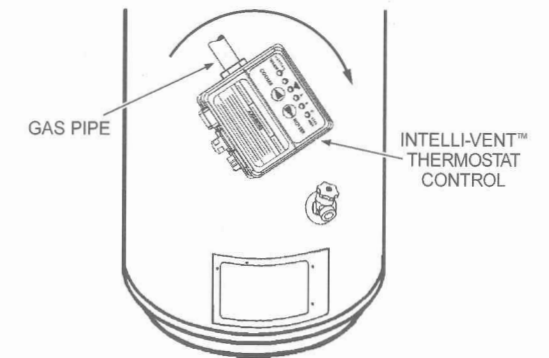

FIGURE 9.

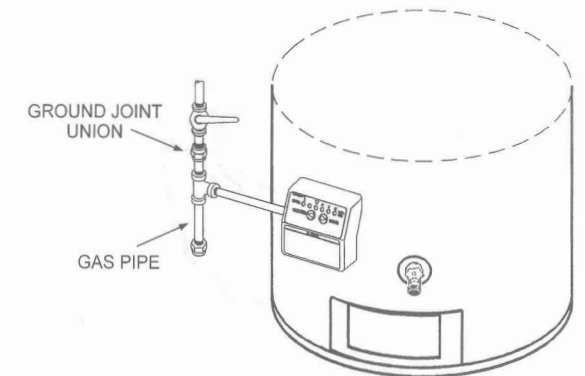

FIGURE 10.

15. Install the burner assembly into the water heater. Make certain that the flat end of the burner supply tubes goes into the slotted opening of the radiation shield and the flared end into the inverted flare opening of the Intelli-vent™ Thermostat Control, (184960 Series), see Figure 11.
16. Hand start threading the burner tube's inverted flare nut into the Intelli-vent™ Thermostat Control, (184960 Series). Use a 3/4 inch open-end wrench to tighten the nut. DO NOT over tighten. DO NOT use joint compound or tape on the union connection, see Figure 11.

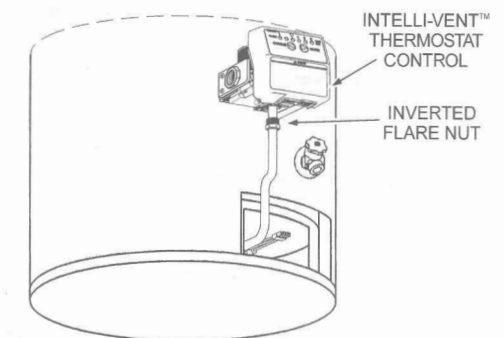

FIGURE 11.

17. Locate the wiring harness and connector that comes out of the water heater's jacket and plug the connector into the Intelli-vent™ Thermostat Control, (184960 Series), see Figure 12.



18. When replacing a 184960 Series gas control with a 184960 Series Gas control, the Ignitor Assembly Connector plugs directly into the gas control, see Figure 12.

If the 184960 Series gas control is replacing a 183760 Series gas control (such as when supplied with a conversion kit - from Propane to Natural gas), it will be necessary to install a "Ignitor Assembly Adapter". Locate the "Ignitor Assembly Adapter" from the kit and plug the male end into the Intelli-vent™ Thermostat Control, (184960 Series). Note: The connector is "keyed" so it can only be inserted one way. Make sure the connector is properly aligned before attempting to insert. Do not force the connector or damage to the control will result, see Figure 13.

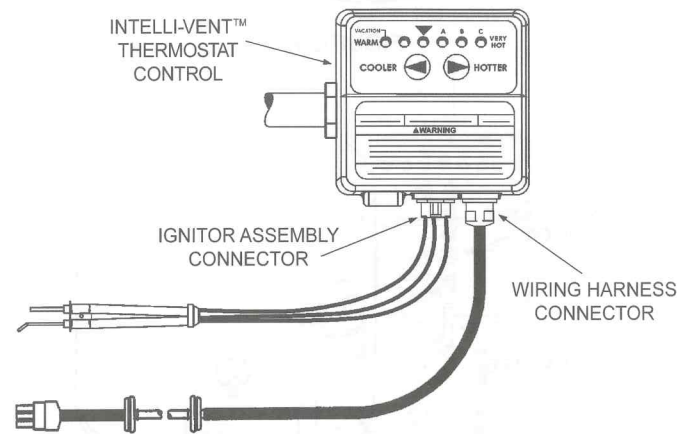

FIGURE 12.

19. Locate the Ignitor Assembly and connector that comes out of the combustion chamber of the water heater and plug the male end of the connector into the female end of the "Ignitor Assembly Adapter", see Figure 13.

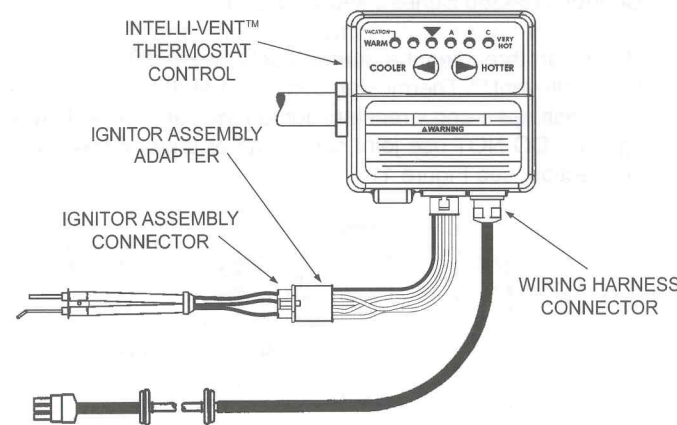

FIGURE 13.

20. Re-install the inner and outer doors to the water heater.
21. The water heater and its gas connection must now be leak tested before placing the water heater in operation. Check for gas leaks with a soap and water solution and a brush or commercial leak detector fluid. **NEVER USE A MATCH OR OPEN FLAME FOR TESTING!**

### CAUTION

The water heater and its individual shutoff valve must be disconnected from the gas supply piping system during any pressure testing of the system at test pressures in excess of 1/2 psi (3.5 kPa). The water heater must be isolated from the gas supply piping system by closing its manual shutoff valve during any pressure testing of the gas supply system at test pressures equal to or less than 1/2 psi (3.5 kPa). The supply line must be capped when not connected to the water heater.

22. Close the drain valve on the water heater by turning the knob clockwise and then detach the hose.
23. Open the cold water supply valve to the water heater and fill the water heater. While the water heater is filling, open several hot water faucets to allow air to escape from the water system. When a steady stream of water flows through the faucets, close and check all water connections for possible leaks. **NEVER OPERATE THE WATER HEATER WITHOUT FIRST BEING CERTAIN IT IS FILLED WITH WATER.**
24. Re-connect and turn on the electrical power to the water heater.

### LIGHTING AND SHUTDOWN INSTRUCTIONS

Follow original procedures found in owners' manual for lighting and shutdown instructions.

### THERMOSTAT ADJUSTMENT

After the gas and electrical connections have been made, the water heater filled with water and the "ON/OFF" switch on the blower control box toggled to the "ON" position, the Emerson (White-Rodgers) Intelli-vent Thermostat Control will start to heat the water to the factory default setting of approximately 120°F (49°C).

To avoid any unintentional changes in water temperature settings, the control has a tamper resistant feature included for changing the temperature setting. If you want to change this setting for either cooler or warmer water, the following steps are necessary:

1. "Wake up" the temperature indicators by depressing both the "COOLER" and "HOTTER" temperature adjustment buttons at the same time for one second (See Figure 13). One or two of the temperature indicators will light up. These indicators will only remain on for 30 seconds if no further button is depressed. After 30 seconds the control will go back into the "Sleep" mode, and both buttons will again have to be depressed to see the water temperature setting.
2. Release both of the temperature adjustment buttons.
3. If this is the first time the control has been adjusted, the indicator below the diamond (?) will be illuminated indicating the water temperature setting is approximately 120°F (49°C). This is the factory default setting, a safe and economical temperature for ordinary use. If the control has been in operation for some time, the water temperature setting may indicate a different temperature.

### To Decrease the Temperature

Press and release the "COOLER" button once. The temperature indicators will not display the new temperature setting. Press and release the "COOLER" button until you have reached the desired setting. Holding down the button will not continue to lower the setting. The button must be pressed and released for each temperature change desired.

### To Increase the Temperature

Press and release the "HOTTER" button once. The temperature indicators will not display the new temperature setting. Press and release the "HOTTER" button until you have reached the desired setting. Holding down the button will not continue to raise the setting. The button must be pressed and released for each temperature change desired. To avoid scald injury, set the control to the lowest setting which will deliver your needed hot water.

### CHECKING OPERATION

Check burner for proper flame characteristics. To accomplish this, remove the outer door and look into the combustion chamber through the inner door. During ignition, the burner should ignite rapidly and smoothly. When the burner is in operation, it should be reasonably quiet in operation.

If proper flame characteristics are not evident, make sure that the flow of combustion and ventilation air is not restricted or blocked and check for accumulation of lint or foreign material that may be restricting or blocking the air openings of the water heater. Also, refer to the "AIR REQUIREMENTS" section of the Owner's Manual.

### NATURAL GAS HOT SURFACE IGNITOR & MAIN BURNER ASSEMBLIES

